

INCH-POUND

MIL-HDBK-1857
27 MARCH 1998

NOTE: Mil-Std-1857 has been redesignated as a Handbook, and is to be used for guidance purposes only. For administrative expediency, the only physical change from Mil-Std-1857 is this cover page. However, this document is no longer to be cited as a requirement. If cited as a requirement, Contractors may disregard the requirement of this document and Interpret its contents only as guidance.

DEPARTMENT OF DEFENSE HANDBOOK

GROUNDING, BONDING AND SHIELDING DESIGN PRACTICES



AMSC N/A

AREA EMCS

DISTRIBUTION STATEMENT A. Approved for public release; distribution is unlimited.

MIL-STD-1857(EL)
30 June 1976

HEADQUARTERS
DEPARTMENT OF THE ARMY
WASHINGTON, D.C. 20310

Grounding, Bonding and Shielding Design Practices

MIL-STD-1857(EL)

1. This Military Standard is approved for use by Electronics Command, Department of the Army, and is available for use by all Departments and Agencies of the Department of Defense.
2. Recommended corrections, additions or deletions should be addressed to Commander, US Army Electronics Command, ATTN: DRSEL-RD-TS-S, Fort Monmouth, N. J. 07703.

FOREWORD

In the past the Department of the Army has required contractors to use a number of bonding and grounding specifications which were primarily intended for use in the development and construction of airborne and shipboard electronic equipment. In general these specifications were considered adequate but because many of the requirements included therein were unique to airborne and shipboard equipments they could not be effectively applied to ground Army equipments.

In light of these shortcomings this standard was developed to provide to the design engineer bonding, grounding and shielding design requirements which can be more effectively applied and are unique to electronic equipments, subsystems and systems deployed by the Department of The Army.

CONTENTS

Paragraph		<u>Page</u>
1.	SCOPE - - - - -	1
2.	REFERENCED DOCUMENTS - - - - -	1
3.	REQUIREMENTS - - - - -	2
3.1	Grounding - - - - -	2
3.1.1	Grounding plane requirements - - - - -	2
3.1.2	Grounding techniques - - - - -	3
3.1.2.1	Floating ground system - - - - -	3
3.1.2.2	Single-point grounding system - - - - -	3
3.1.2.3	Multipoint grounding system - - - - -	3
3.1.3	Ground connections - - - - -	3
3.1.4	Distribution of chassis potential - - - - -	5
3.1.5	Grounding of shields - - - - -	9
3.1.5.1	Equipment - - - - -	9
3.1.5.2	Cable grounding - - - - -	9
3.1.5.3	Printed circuit boards - - - - -	11
3.1.6	Circuit grounding - - - - -	11
3.1.7	Power supplies - - - - -	16
3.2	Bonding - - - - -	16
3.2.1	General - - - - -	16
3.2.1.1	Bond effectiveness - - - - -	16
3.2.1.2	Design requirements - - - - -	18
3.2.1.3	Bonding jumpers (straps) - - - - -	18
3.2.2	Types of bonds - - - - -	18
3.2.2.1	Direct bonds - - - - -	19
3.2.2.2	Indirect bonds - - - - -	19
3.2.2.3	Bond-straps - - - - -	19
3.2.3	Bonding metal selection and bond- strap finishes - - - - -	22
3.2.4	Bonding applications - - - - -	24
3.2.4.1	Shock mounts - - - - -	24
3.2.4.2	Rotating joints - - - - -	29
3.2.4.3	Tubing conduit - - - - -	29
3.2.4.4	Hinges - - - - -	29
3.2.4.5	Cable trays - - - - -	29
3.2.5	Bonding practices summarized - - - - -	29
3.2.6	Grounding requirements - - - - -	33
3.2.7	Earth ground - - - - -	33
3.2.7.1	Ground resistance - - - - -	33
3.2.7.2	Grounding in sub zero zones - - - - -	37

CONTENTS - Continued

Paragraph		<u>Page</u>
3.2.8	Separation of ac neutral from frame ground - - - - -	37
3.2.9	Marine craft bonding and grounding methods - - - - -	39
3.3	Shielding - - - - -	39
3.3.1	General - - - - -	39
3.3.2	Shielding effectiveness - - - - -	39
3.3.3	Cable shielding - - - - -	42
3.3.4	Case and front panel shielding - - - - -	45
3.3.5	Shielding design fundamentals - - - - -	45
3.3.6	Multiple shielding- - - - -	52
3.3.6.1	General - - - - -	52
3.3.6.2	Multiple shielding applications - - - - -	53
3.3.7	Enclosure seam design - - - - -	53
3.3.8	Screening - - - - -	57
3.3.9	Shielding of apertures - - - - -	57
3.3.9.1	General - - - - -	57
3.3.9.2	Waveguide attenuation characteristics - - - - -	60
3.3.10	Fasteners - - - - -	64
3.3.11	Conductive gaskets - - - - -	69
3.3.11.1	General - - - - -	69
3.3.11.2	Application - - - - -	72
3.3.11.3	Fastening material - - - - -	72
3.3.11.4	Equipment panels - - - - -	72
3.3.11.5	Conductive Elastomer Materials - - - - -	77
3.3.11.6	Pressure and rain seals - - - - -	77
3.3.11.7	Connector seals - - - - -	77
3.3.11.8	Characteristics of conductive gasket material - - - - -	79
3.3.11.9	Shielding enhancement by conductive gaskets - - - - -	81
3.3.11.10	Qualification of gasket material - - - - -	82
3.3.12	Insertion loss - - - - -	83
3.3.13	Classification of joints - - - - -	83
3.3.13.1	General - - - - -	83
3.3.13.2	Conductive gasket selection - - - - -	88
3.3.14	Special shielding techniques - - - - -	88
3.3.14.1	Gas discharge lamps - - - - -	88
3.3.14.2	Magnetic shielding techniques - - - - -	90
3.3.14.3	Data output openings - - - - -	93
3.3.14.4	Direct view storage tubes - - - - -	93
3.3.14.5	Cathode-ray tubes - - - - -	96

CONTENTS - Continued

		<u>Page</u>
Paragraph	3.3.14.6	Indicating and elapsed time meters 96
	3.3.14.7	Fuse holder and indicator lamp openings - - - - - 96
	3.3.14.8	Switching devices - - - - - 98
	3.3.14.9	Conductive surface coatings - - - - 100
	3.3.15	Cabling - - - - - 103
	3.3.15.1	General - - - - - 103
	3.3.15.2	Cable shielding - - - - - 103
	3.3.15.3	Cable types - - - - - 104
	3.3.15.4	Required cable characteristics - - 105
	3.3.16	Cable connectors - - - - - 109
	3.3.17	Cable application - - - - - 109
	3.3.17.1	General - - - - - 109
	3.3.17.2	Magnetic coupling - - - - - 112
	3.3.17.3	Multiconductor shielding - - - - - 113
	3.3.17.4	Design requirements - - - - - 113
	3.3.18	Cable shield grounding - - - - - 114
	3.3.18.1	General - - - - - 114
	3.3.18.2	Special design features - - - - - 116
	3.3.18.3	Termination of shields - - - - - 116
	3.3.18.4	Isolation - - - - - 120
	3.3.19	Cable-shield bonding - - - - - 122
	3.3.20	Cable routing - - - - - 122
	3.3.20.1	Crosstalk - - - - - 122
	3.3.20.2	Circuit coupling effects - - - - - 124
	3.3.20.3	Transient response - - - - - 128
	3.3.20.4	Common-impedance cabling elements - 135
	3.3.20.5	Power cabling - - - - - 136
	3.3.20.6	Waveguides - - - - - 138
	3.3.21	Equipment mounting - - - - - 139
	3.3.21.1	General - - - - - 139
	3.3.21.2	Rack bonding - - - - - 139
	3.3.21.3	Cabinet shielding and equipment location - - - - - 142

FIGURES

Figure	1	Ground Systems - - - - -	4
	2	Ground Lug Connection and Equivalent Circuit - - - - -	6
	3	Grounding methods - - - - -	7
	4	Typical Ground Potential Graph at a Specific Frequency - - - - -	8
	5	Single-Point Ground Bus Arrangement	10

FIGURES - Continued

Figure		<u>Page</u>
6	Direct Use of Chassis for Good Ground - - - - -	12
7	Example of Intercircuit Coupling -	13
8	Effect of Circulating Currents on a Typical Circuit - - - - -	14
9	Isolation Transformer Technique for Minimizing Ground Potential - - -	14
10	Equivalent Circuit of Ground Noise in Electronically Coupled Circuits	15
11	Electronically Coupled Circuit with Ground Noise - - - - -	15
12	Bonding Strap Impedance Characteristics - - - - -	17
13	Recommended Bond Strap Bolting Installation - - - - -	20
14	Impedances of Bond-Straps and No. 12 AWG Wire - - - - -	21
15	Typical Shock Mount Bond - - - - -	26
16	Bonded Engine Shock Mount-Front - -	27
17	Bonded Engine Shock Mount-Rear - -	28
18	Cable and Conduit Bonding - - - - -	30
19	Bonding of Hinges - - - - -	31
20	Cable Tray Section Bonding - - - - -	31
21	Equipment Cabinets Bonded to Cable Tray - - - - -	32
22	Soil Classification Chart - - - - -	34
23	Variation of Soil Resistance with Temperature - - - - -	35
24	Effect of Moisture Content on Soil Resistance - - - - -	36
25	Metal Shielding Effectiveness - - -	40
26	Shield-Constructional Details - - -	43
27	Multiple Shielding Applications - -	54
28	Seam Design for Minimum Interference	55
29	Vertical Expansion Joint, an Example of a Complex Seam - - - - -	56
30	Air Impedance of Perforated Metal and Honeycomb - - - - -	58
31	Air Impedance of Copper and Nickel Mesh - - - - -	58
32	Honeycomb Type Ventilation Panel -	59
33	Attenuation-Rectangular Waveguide -	61
34	Attenuation-Circular Waveguide - -	62
35	Tube Acting as Waveguide Attenuator	65
36	Shaft Feedthrough Techniques - - -	65

FIGURES - Continued

Figure		<u>Page</u>
37	Buckling between Fasteners with Thin Material - - - - -	66
38	Seam Treatment with Mesh Gaskets -	68
39	Improper Gasket Application - - - -	70
40	Flat-Flange Tupe Joint - - - - -	71
41	Flat-Flange Type Joint with Groove Gasket - - - - -	71
42	Typical Groove Type Gasket Applications - - - - -	73
43	Typical Conductive Gasket Applications - - - - -	73
44	Typical Gasket Mounting Methods - -	74
45	Various Gasket Configurations - - -	75
46	Typical Conductive Gasketing Problem	76
47	Pressurized Conductive Gasket Application - - - - -	78
48	Raintight Conductive Gasket Seal -	78
49	Insertion Loss vs. Pressure for Resilient Metal Gasket - - - - -	84
50	Technique for Measurement of Insertion Loss of Resilient Metal Gasket - - - - -	85
51	Interference Gasket of the Armour Research Type - - - - -	86
52	Metal-to-Metal Contact Techniques of Cover and Case for Interference Shields - - - - -	87
53	Effect of Joint Orientation on Flux Paths - - - - -	91
54	Shield Economics - - - - -	91
55	Meter Shielding and Isolation - - -	94
56	Treatment of Cathode Ray Tube Openings - - - - -	97
57	Magnetic and Electrostatic Cable Shielding - - - - -	99
58	Typical Conductive Caulking Applications - - - - -	101
59	Connector with Shielding Shell Enclosure for Connecting Points - -	115
60	Power Frequencies Coupled into Low-Level Circuit Using Multipoint Shield Grounds - - - - -	117
61	Reduction of Signal and Power Frequency Coupling by Shielded, Twisted-Pair Cable - - - - -	117

FIGURES - Continued

Figure		<u>Page</u>
62	Incorrect Method of Introducing Shielded Cable - - - - -	118
63	Correct Method of Introducing Shielded Cable - - - - -	118
64	Continuous Equipment Enclosure Shield - - - - -	119
65	Cable Shield Bonding - - - - -	121
66	Triaxial Cable Application - - -	123
67	Typical Cabling Methods - - - - -	125
68	Magnetic Coupling - - - - -	127
69	Capacitively Coupled Circuits - -	130
70	Equivalent Circuit for Derivation of Coupled Signal - - - - -	132
71	Coupling Signal Resulting from Step Voltage - - - - -	132
72	Cable Circuit Configurations - -	134
73	Dimensions of Flat-Conductor Flexible Cable - - - - -	134
74	Cabinet Bonding Modifications - -	140
75	Typical Cabinet Bonding Arrangements - - - - -	141
B-1	Shielding Effectiveness in Electric, Magnetic and Plane Wave Fields of Solid Copper and Iron Shields (For Signal Source 12 inches from Shield at 100 Hz to 10 GHz - - - - -	158
B-2	Total Reflection Loss at Both Surfaces of a Solid Steel Shield	159
B-3	Total Reflection Loss at Both Surfaces of a Solid Copper Shield	160
B-4	Absorption Loss for Steel and Copper Shields at 30 Hz to 10,000 MHz - - - - -	161
B-5	Shielding for Transmission Cable	162
B-6	Values of Equivalent Series RF Resistance of Uncoated Aluminum Sections Before and After 64-hour Salt Spray Test - - - - -	163
B-7	Values of Equivalent Series RF Resistance of Chromate-Treated Aluminum Sections Before and After 64-hour Salt Spray Test -	163
B-8	Typical Welded Screen Installation Over a Ventilation Aperture - -	164

FIGURES - Continued

Figure		<u>Page</u>
B-9	Typical Clamped Screen Installation Over a Ventilation Aperture - - - - -	164
B-10	Shielding Effectiveness of Various Copper Screens - - - - -	165
B-11	Shielding Effectiveness of Various Galvanized Steel Screens - -	166
B-12	Comparison of the Shielding Effectiveness of Single and Double 18 Mesh Copper Screening-	167
B-13	Comparison of the Shielding Effectiveness of Single and Double 40 Mesh Copper Screening-	168
B-14	Comparison of the Shielding Effectiveness of Single and Double 69 Mesh Copper Screening-	169
B-15	Comparison of the Shielding Effectiveness of Single and Double 8 Mesh Galvanized Steel Screening - - - - -	170
B-16	Attenuation Versus Frequency Curves for Various Screens - - -	171
B-17	Attenuation Versus Frequency Curves for Various Screens Honeycomb - - - - -	172
B-18	Minimum Shielding Effectiveness of Copper and Bronze Screening in a Magnetic Field - - - - -	173
B-19	Minimum Shielding Effectiveness of Steel Screening in a Magnetic Field - - - - -	174

TABLES

Table	I	Electromotive force series of commonly used metals - - - - -	23
	II	Fasteners, Hardware - - - - -	25
	III	Design guide-shield wire size - -	44
	IV	Values of G and μ - - - - -	47
	V	Absorption loss - - - - -	50
	VI	Absorption loss of metals at 150 kHz - - - - -	51

TABLES - Continued

Table		<u>Page</u>
Table VII	Characteristics of conductive gasketing materials - - - - -	79
VIII	Guide to choice of type of RF gasket based on mechanical suitability - - - - -	89
IX	Microwave and optical properties of semitransparent shielding materials - - - - -	95
X	Conductive surface applications -	102
XI	Connector application summary -	
	A. New equipment	110
	B. Existing equipment	111
XII	Wire twist - - - - -	129
A-I	Reflection loss - - - - -	144
A-II	B-factors in electric, magnetic, and plane wave fields of solid copper and iron shields - - - - -	145
A-III	Total reflection loss in electric field (wave impedance much greater than 377 ohms) at both surfaces of solid steel and copper shields - - - - -	146
A-IV	Total reflection loss in magnetic field (wave impedance much smaller than 377 ohms) at both surfaces of solid steel and copper shields - - - - -	147
A-V	Total reflection loss in plane wave field (wave impedance equals 377 ohms) at both surfaces of solid steel and copper shields - - - - -	148
A-VI	Loss of steel and copper shields at 30 Hz to 10 GHz - - - - -	149
A-VII	Examples for calculating shielding effectiveness of solid-metal shield - - - - -	150
A-VIII	Mesh, wire and aperture sizes for typical screening materials - - -	151
A-IX	Mesh, wire and aperture sizes for screening materials tested - - -	152
A-X	Characteristics of typical perforated sheet stock - - - - -	153

APPENDICES

		<u>Page</u>
Appendix	A.	Characteristics of Material - - - - 143
	B.	Shielding Characteristics of Material - - - - - 157

GROUNDING, BONDING AND SHIELDING DESIGN PRACTICES

1. SCOPE

1.1 This standard covers the characteristics of grounding, bonding and shielding design practices to be applied in the construction and installation of marine, fixed station; trans-portable and ground mobile electronic equipment, subsystem and system.

2. REFERENCED DOCUMENTS

2.1 Issues of documents. The following documents of the issue in effect on date of invitation for bids or request for proposal form a part of this standard to the extent specified herein:

SPECIFICATIONS

MILITARY

MIL-P-11268

Parts, Materials and Processes
(Used in Electronic Equipment).
Finishes for Ground Electronic
Equipment

MIL-F-14072

STANDARDS

FEDERAL

Federal Test Method
Standard No. 406
Federal Test Method
Standard No. 601

Plastics: Method of Testing.

Rubber: Sampling and Testing

MILITARY

MIL-STD-454

Standard General Requirements
for Electronic Equipment
Environmental Test Methods
Shipboard Bonding and Grounding
Methods for Electromagnetic
Compatibility

MIL-STD-810
MIL-STD-1310

(Copies of specifications, standards, drawings and publications required by contractors in connection with specific procurement functions should be obtained from the procuring activity or as directed by the contracting officer.)

2.2 Other publications. The following document forms part of this standard to the extent specified herein. Unless otherwise indicated in the individual equipment specification, the issue in effect on date of invitation for bids or request for proposal shall apply.

SOCIETY OF AUTOMOTIVE ENGINEERS, INC. (SAE)

SAE-ARP-1173

Test Procedure to Measure the
R.F. Shielding Characteristics
of EMI Gaskets.

(Copies may be obtained from the Society of Automotive Engineers, Inc. 485 Lexington Avenue, New York, New York 10017.)

3. REQUIREMENTS

3.1 Grounding. This standard establishes various grounding techniques that should be used during the design of electrical and electronic equipment. During the design stages, establishment of and systematic cable, wiring, and equipment grounding will minimize interference difficulty after installation. It is not possible to have a set of fixed rules governing grounding of electronic or electrical circuits or equipment, the rules presented here should be adapted by the design engineer to a particular grounding problem.

3.1.1 Grounding plane requirements. A good, basic ground plane is the foundation for obtaining reliable, interference-free equipment operation. An ideal ground plane will have high capacitance to interconnect wiring and plane members will have low segment inductances. Ideally, it must be able to absorb all signals while remaining stable. An ideal ground plane will provide equipment with a common potential reference point anywhere in the system, to eliminate undesirable voltages. A ground plane should be constructed of a low-impedance material, such as copper,

and be large enough in length, width, and thickness to provide a low impedance between its extremities at all frequencies. The ground plane for a fixed location plant facility should consist of a continuous sheet of copper or a grid of copper conductors 10' x 10' on center spacing or less. The copper sheet is required for multitransmitter plants. VLF transmitters present special problems frequently requiring unique solution. The ground plane should present a high capacity to earth. It should extend continuously under all equipment areas in the building, and extend six feet or more beyond the limits of the equipment area(s). High power multitransmitter plants require ground radials extending from the ground plane a quarter wave length at the lowest operating frequency to permit removal of ground currents. The dc resistance to earth must be low to prevent large changes in ground plane potential produced by conducted or induced currents. Ground stakes driven into the permanent water table and bonded to the ground plane will provide an earth connection of ten ohms or less. In extreme cases, where ground resistance is high and the permanent water table is deep, as in desert areas, drilled wells are required to provide a low impedance dc ground. Equipment ground tie points shall be provided by a conveniently located ground bus bonded to the ground plane by copper strap at intervals of six feet or less.

3.1.2 Grounding techniques. There are three fundamental grounding techniques that shall be employed. Figure 1 illustrates each of these techniques. They shall be used separately or in combination. They are:

3.1.2.1 Floating ground system. In the floating ground method, Fig. 1A, the ground plane is not returned to earth.

3.1.2.2 Single-point grounding system. In the single-point grounding method, Fig. 1B, a single physical point in the circuitry is designated as a ground reference point. All ground connections are made to this point.

3.1.2.3 Multipoint grounding system. The multipoint grounding system is one in which a ground plane (Fig. 1C), for example, an entire chassis, is used instead of individual return wires for each of the circuits.

3.1.3 Ground connections. A ground point is the physical location where a circuit, piece of equipment, or system is

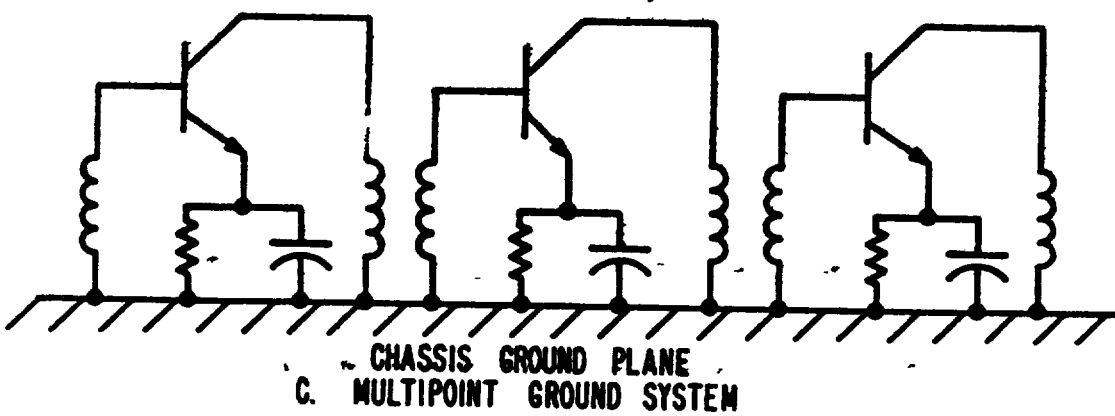
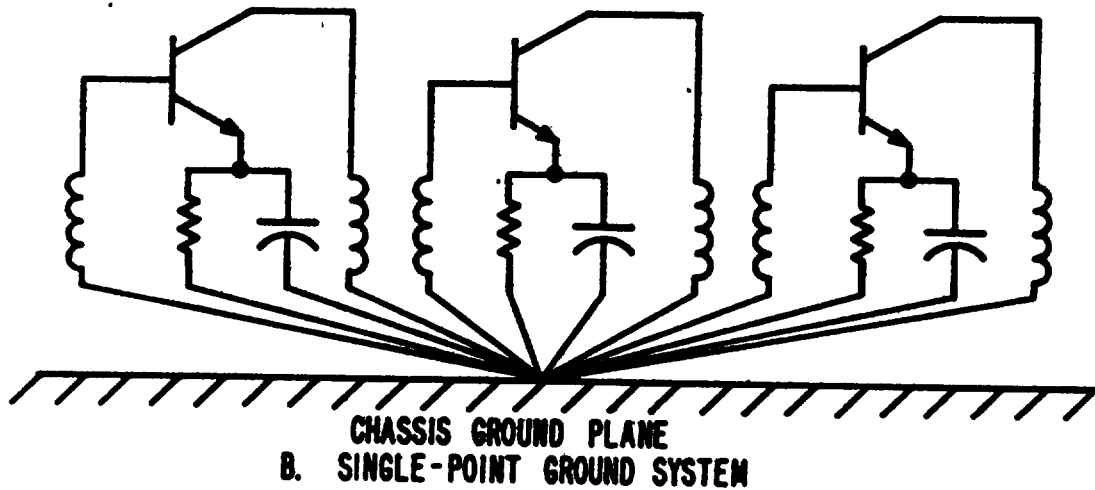
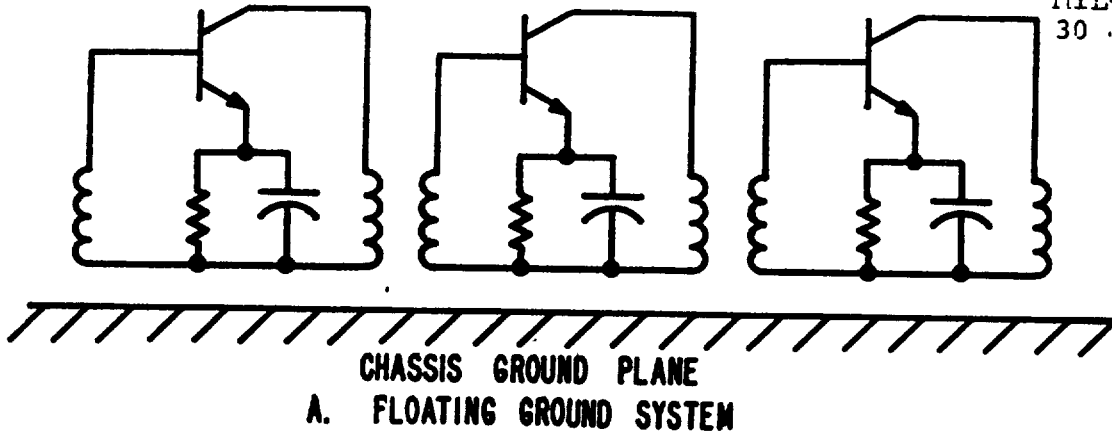

FIGURE 1. GROUND SYSTEMS

connected to the ground plane. The impedance of a ground connection is a function of such factors as the size of conductors, the length of leads, and wiring techniques. A ground connection properly made will promote the satisfactory operation of the circuit. Several factors must be considered for this:

- a. Every wire has a definite inductance.
- b. A current flowing through a wire induces flux around the wire.
- c. As operating frequencies increase, inductive reactance causes circuit impedance to increase.
- d. The resonant frequencies of even small inductances acting with circuit capacitance often fall within the operating frequency of the circuit.
- e. As radio frequencies increase, skin effect becomes an important consideration.

A low-impedance ground connection requires the ground leads to be wide and of short length and be securely bonded directly to the ground plane. A representative ground lug connection and its equivalent circuit is shown on Figure 2. Figure 3A illustrates improper method of connecting power and signal grounds. As the frequency increases, the inductance of the ground jumper becomes appreciable and should be grounded correctly. Figure 3B shows the proper method of installing a ground to avoid conducting interference through the connector.

3.1.4 Distribution of chassis potential. A chassis is not always at zero-signal potential at all points. A typical plot of the chassis-potential of a ground plane is shown on Figure 4. On this figure, the dark areas surround ground lugs or shields in high-voltage and/or high-current areas where the power is sufficient to create a signal on the physical ground plane. A potential plot, will aid in determining the location of low potential or equipotential points that can be used in grounding sensitive circuits. A matter of an inch in the location of ground points can make a difference of several millivolts in the potential between two ground points. A designer, during the initial stages of development, should consider a potential plot in selecting ground points. Marginal ground-point location shall be avoided.

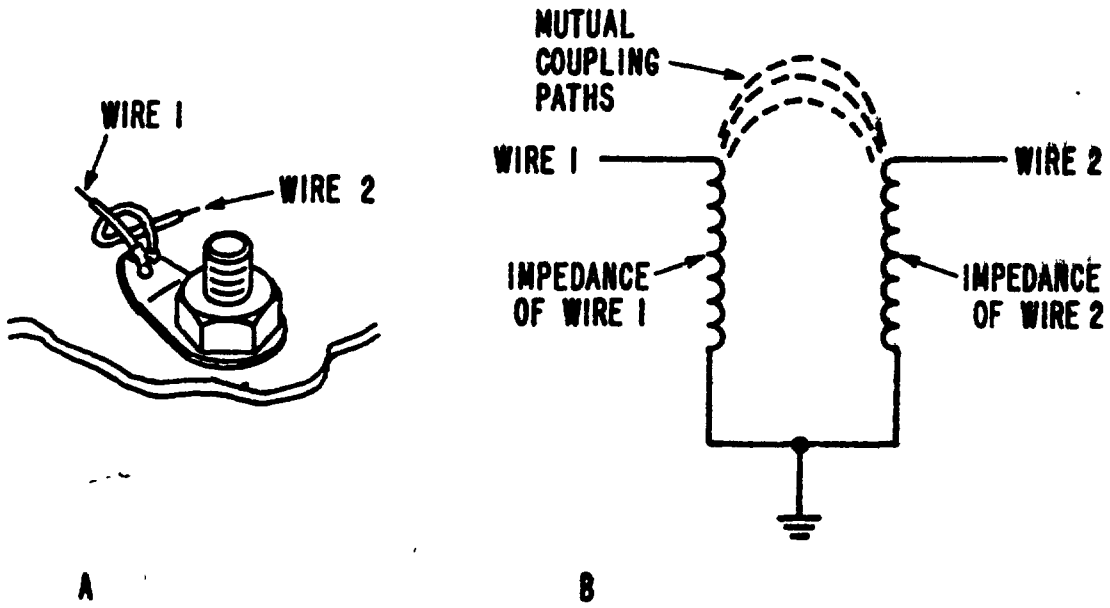
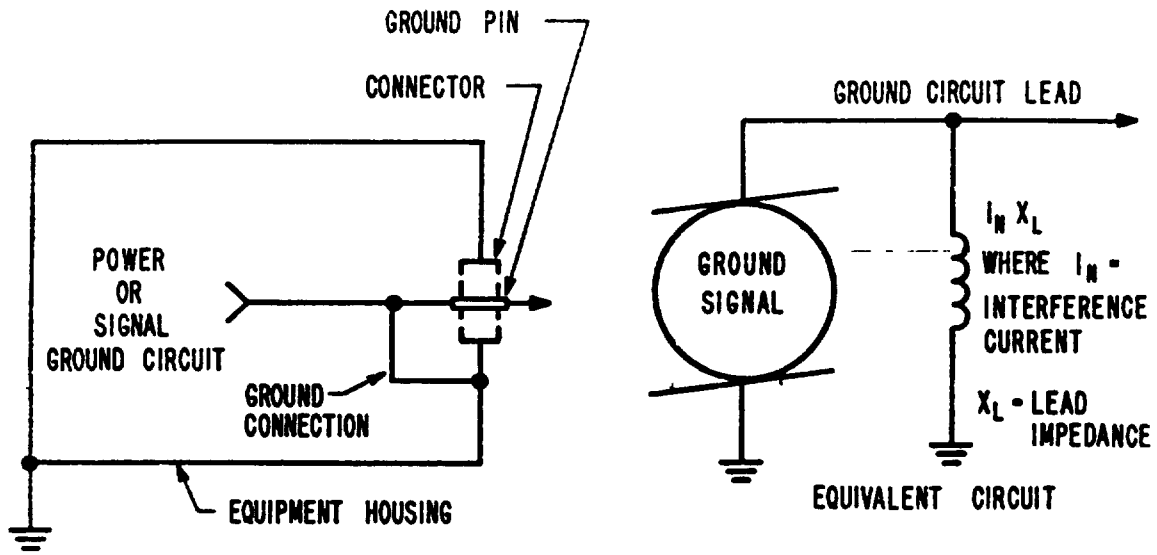
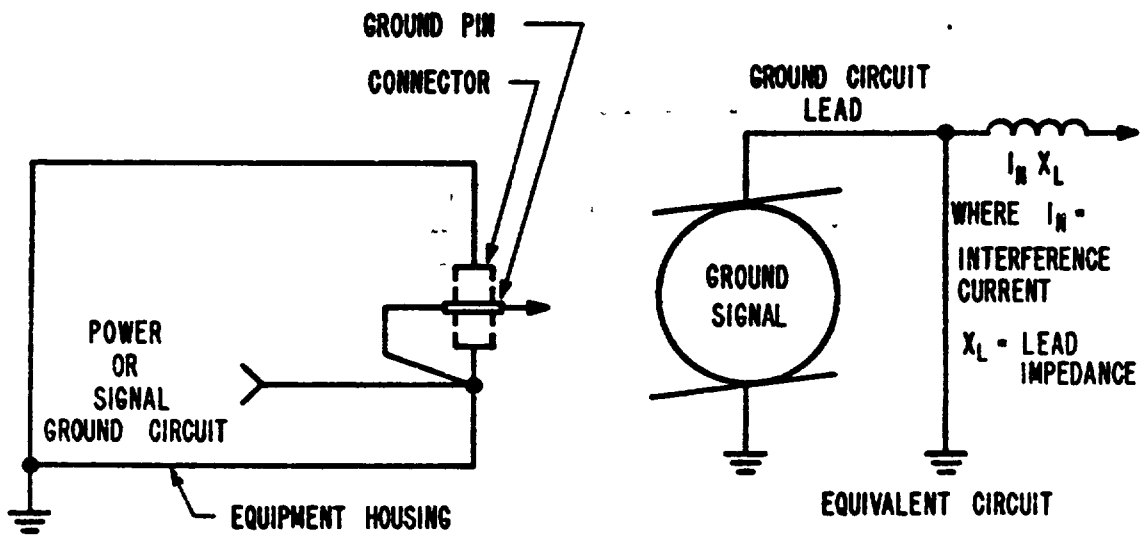

FIGURE 2. GROUND LUG CONNECTION AND EQUIVALENT CIRCUIT



A. IMPROPER METHOD OF MAKING GROUND CONNECTIONS IN ELECTRICAL AND ELECTRONIC EQUIPMENT



B. PROPER METHOD OF GROUNDING FOR MAXIMUM INTERFERENCE REDUCTION

FIGURE 3. GROUNDING METHODS

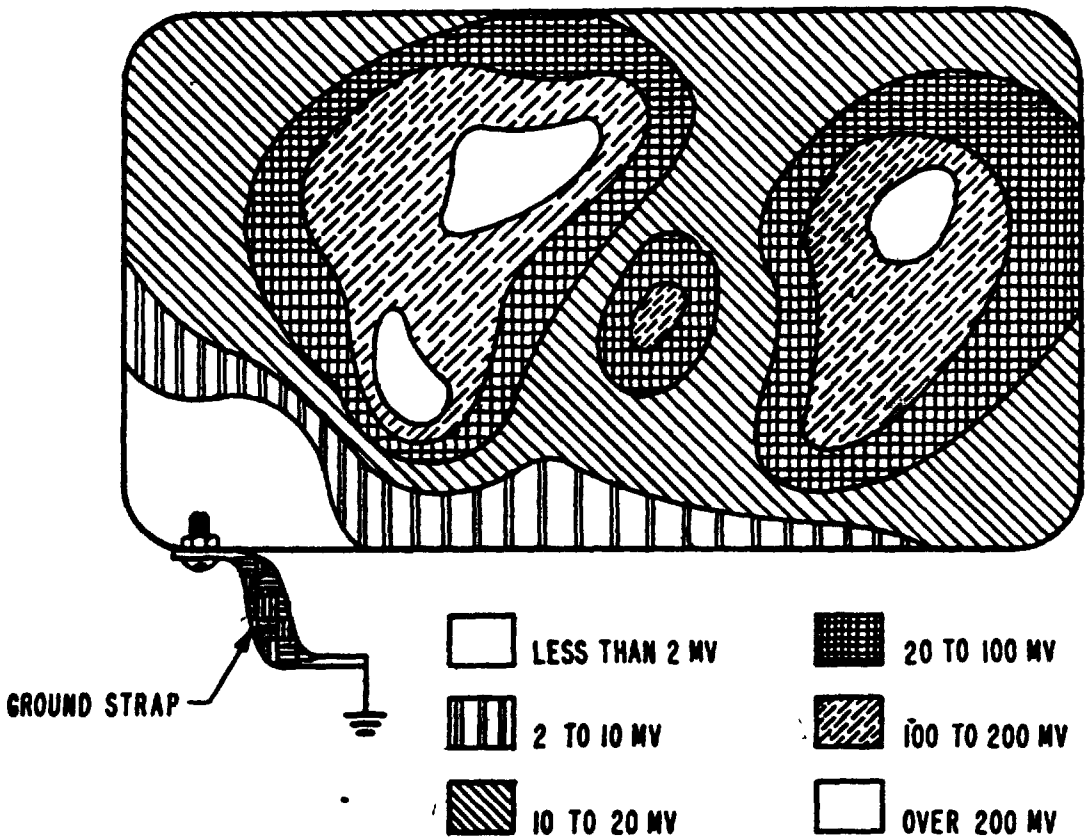

FIGURE 4. TYPICAL GROUND POTENTIAL GRAPH AT A SPECIFIC FREQUENCY

Tolerances encountered in production can result in further difficulties so that a discriminate initial choice of locations is required. It is advantageous at times to run a longer ground wire to utilize a low potential location on a ground plane.

3.1.5 Grounding of shields.

3.1.5.1 Equipment. Grounds for apparatus housed within a shield should be arranged so that the shield is not used as a return conductor. The grounding system should use a ground bus or ground plate near the shield that is insulated from the shield except at a single point (ground point). This ground point should provide the only ground connection for the apparatus within the shield, as illustrated on Figure 5.

3.1.5.2 Cable grounding. The problem of electrical compatibility in a complex electrical or electronic system is dependent on the treatment of the shielding and the grounding of the shields of interconnecting leads. Grounding of the shields should be accomplished as single-point grounding. The selection of single-point grounding is recommended for electromagnetic compatibility.

3.1.5.2.1 Single-point shield grounding. For multi-lead systems, each shield should be grounded at a single point and individual shields should be insulated from each other. Single-point grounding is required for EMC, for short shield lengths. Single-point grounding is ineffective in reducing magnetic or electrostatic coupling when lead length-to-wave length (L/λ) ratios are greater than 0.15, where the wavelength is determined by the highest frequency to be used in the system. To find L/λ use:

$$\frac{L}{\lambda} = \frac{L \text{ (in meters)} \times \text{frequency (in Hertz)}}{3 \times 10^8 \text{ meters/sec.}}$$

3.1.5.2.2 Multipoint shield grounding. For L/λ ratios greater than 0.15, multi-point grounding at intervals of 0.15λ is required. When grounding the shield at intervals of 0.15λ is impractical, shields should be grounded at each end.

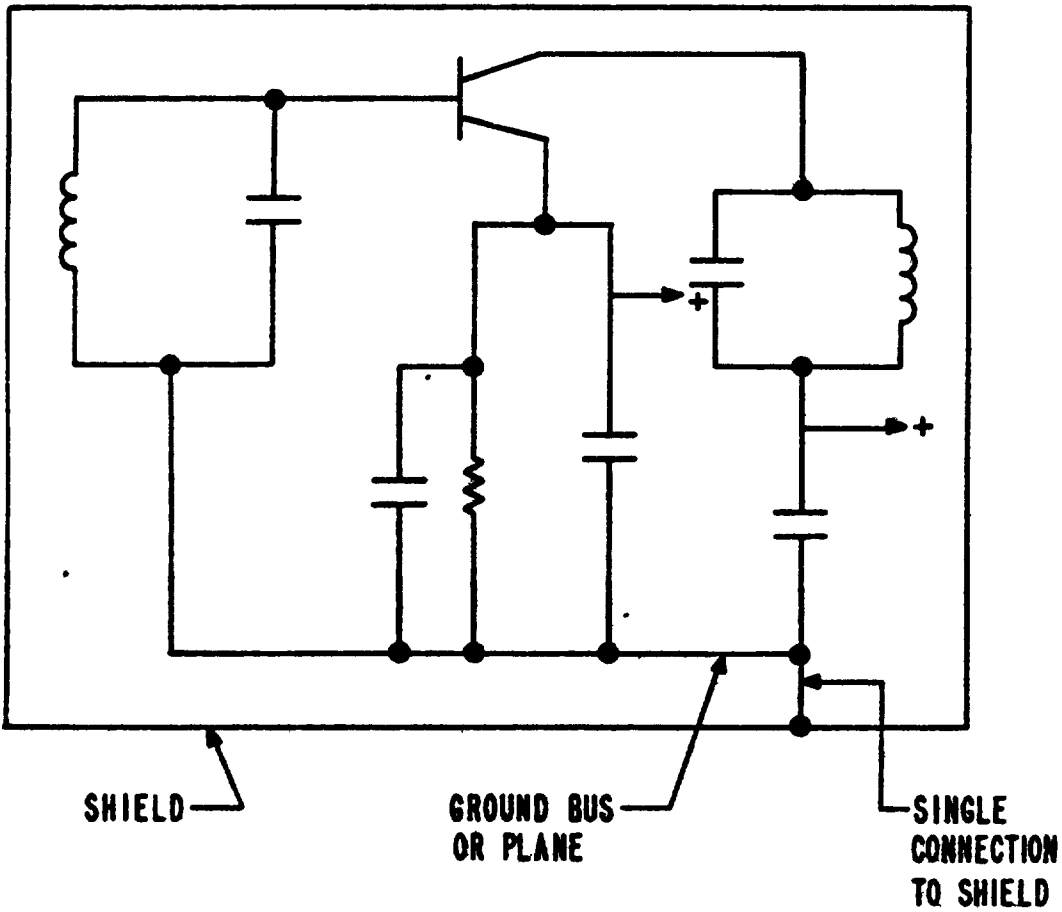

FIGURE 5 SINGLE-POINT GROUND BUS ARRANGEMENT

3.1.5.3 Printed circuit boards. For maximum shielding and isolation, shields on printed-circuit boards should be grounded directly to the main chassis. A typical problem would be the grounding of a shield for an RF transformer located on a printed-circuit board. The purpose of the shield is to prevent stray flux lines of the transformer from coupling into other circuits. Grounding this type of shield shall be made directly to the main chassis, as illustrated on Figure 6.

3.1.6 Circuit grounding. The electronic ground plane in equipment shall exhibit a low-impedance characteristic for all frequencies encountered in the system, and should be used as a common ground return. Interference voltages must be considered when defining the permissible ambient noise level in the system and when determining the expected signal-to-noise ratio. Each electronic circuit contributes its own ground currents. Any ground return path that goes around corners or crosses other return paths causes intercircuit or interstage coupling (Figure 7). The ground plane shall prevent return currents from creating a voltage that causes interference at the input terminals of sensitive circuits. The magnitude of this interference voltage is dependent upon impedance between the circuit ground points in the ground plane, and the current in the ground plane (Figure 8). The current (I) of the low-impedance circuit produces a potential (IZ_{gp}) in the high-impedance circuit. The simplest and most direct approach to this problem is to arrange circuit components physically so that ground return paths are short and direct and have the fewest possible crossings. In this way, the inter-circuit coupling of these ground currents will be kept to a minimum. The effect of ground potential can be cancelled by electrically isolating the circuits. An example of this technique is the isolation transformer shown on Figure 9. This method is especially effective at audio and low radio frequencies. Above these frequencies, its effectiveness progressively diminishes because, as the frequency of ground potential increases, more coupling paths appear. At radio frequencies, this potential must be considered as a voltage source in series with the signal return circuit and should be considered when designing critical low-level circuitry (Figure 10). A typical design for coupled circuit that considers the ground potential is shown on Figure 11.

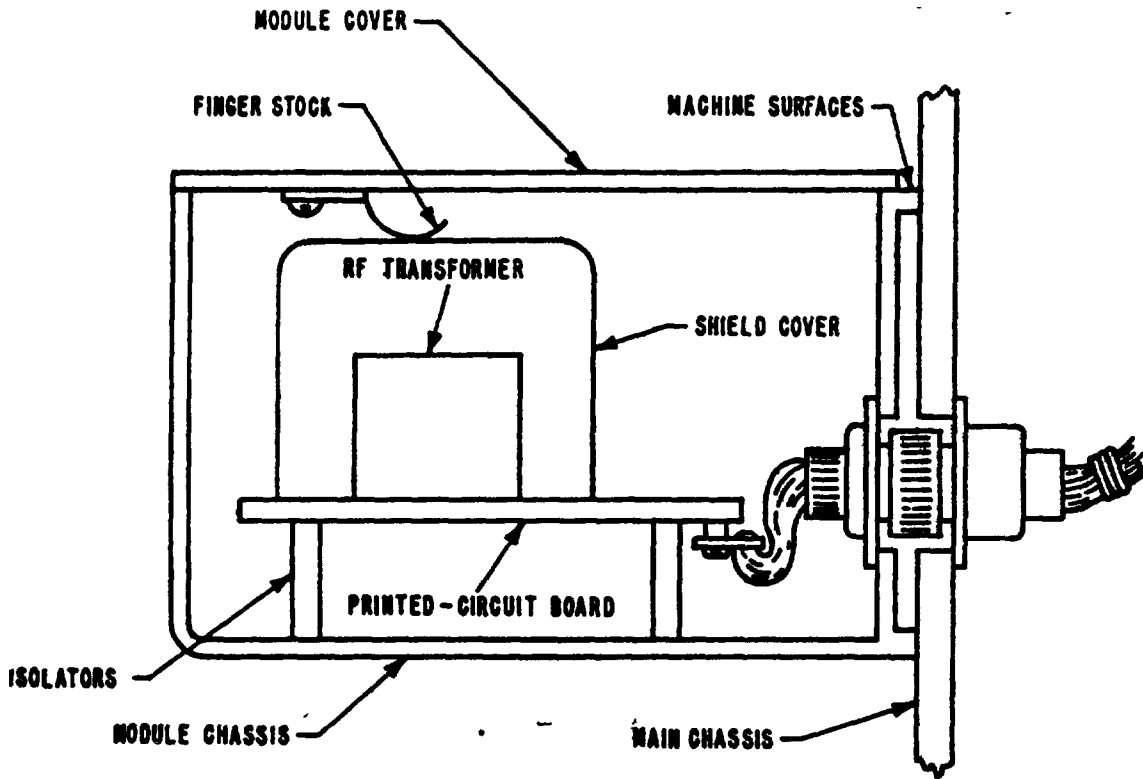

FIGURE 6. DIRECT USE OF CHASSIS FOR GOOD GROUND

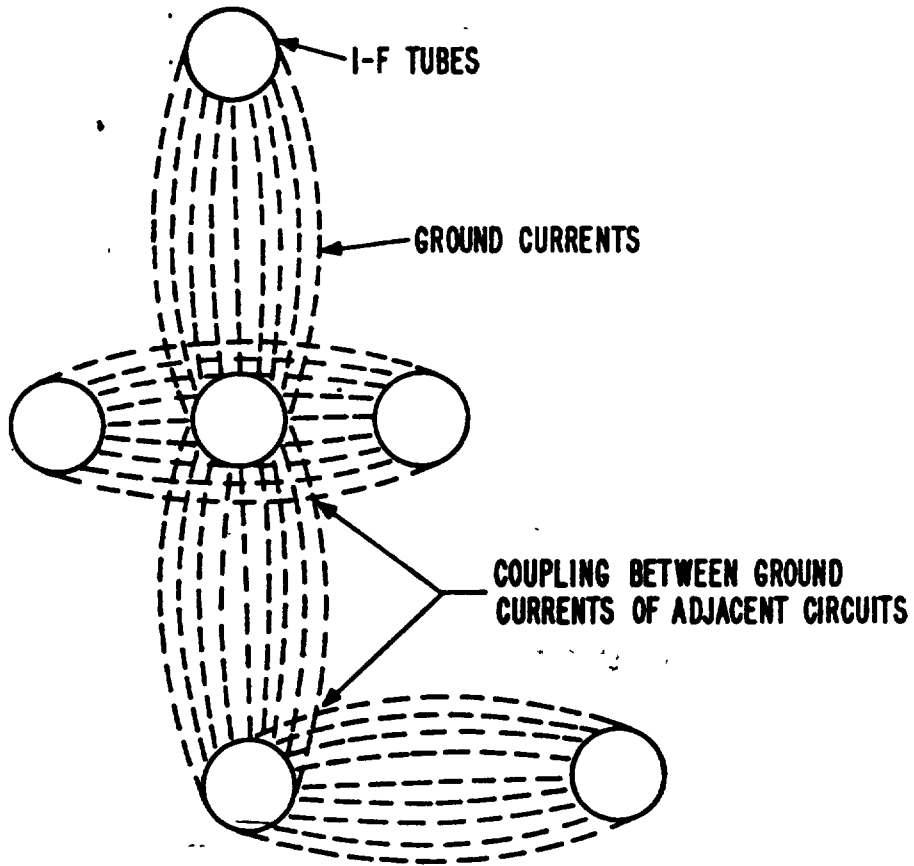
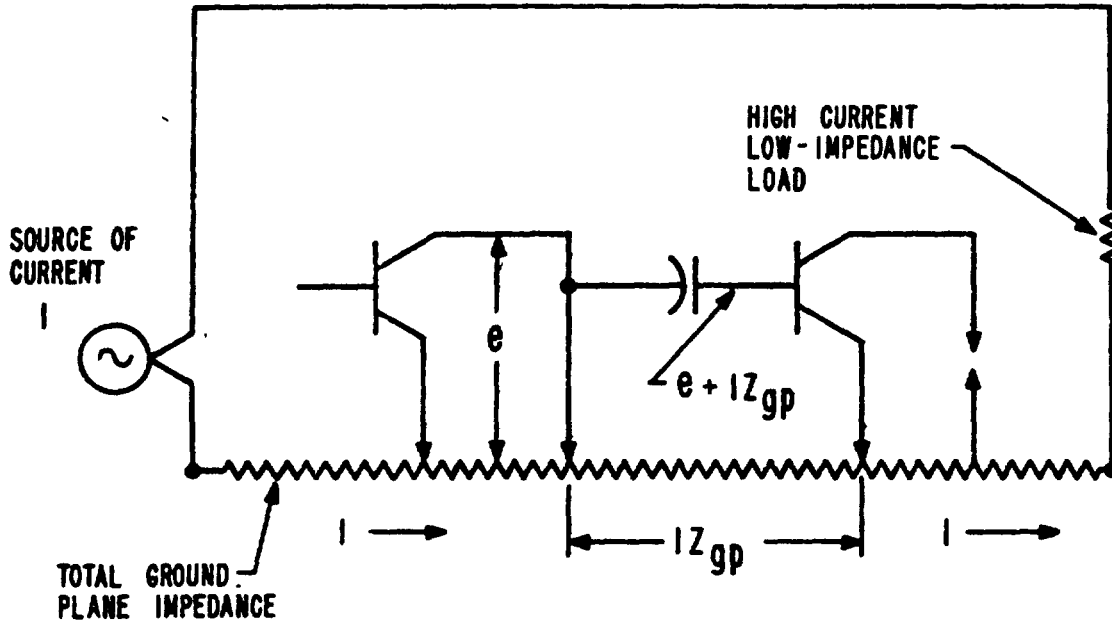

FIGURE 7. EXAMPLE OF INTERCIRCUIT COUPLING



WHERE Z_{gp} = GROUND PLANE IMPEDANCE BETWEEN POINTS A & B

$I Z_{gp}$ = EFFECTIVE APPLIED VOLTAGE

FIGURE 8. EFFECT OF CIRCULATING CURRENTS ON A TYPICAL CIRCUIT

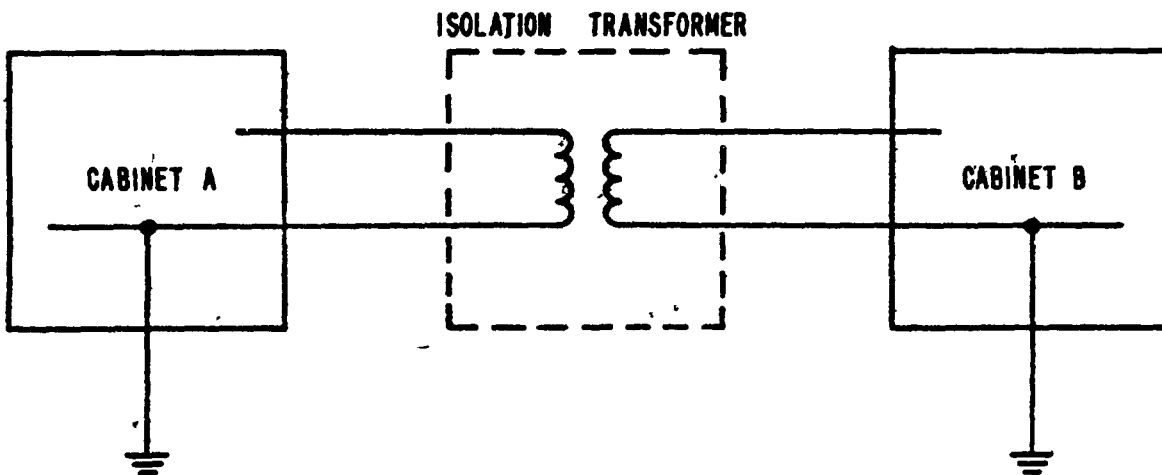

FIGURE 9. ISOLATION TRANSFORMER TECHNIQUE FOR MINIMIZING GROUND POTENTIAL

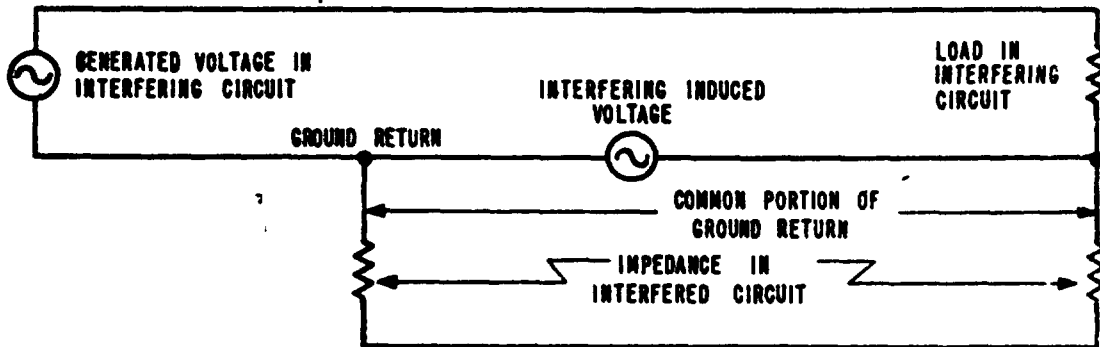

FIGURE 10. EQUIVALENT CIRCUIT OF GROUND NOISE IN ELECTRONICALLY COUPLED CIRCUITS

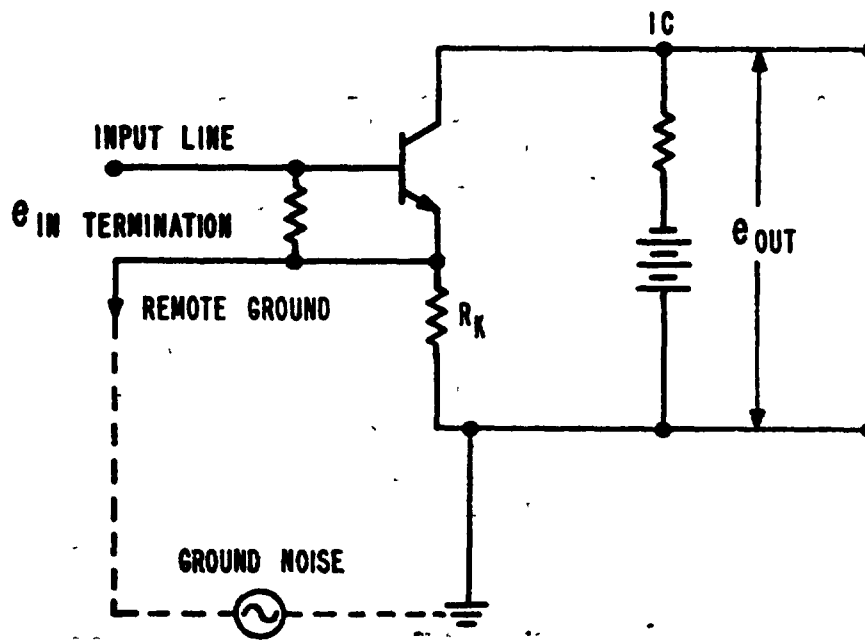

FIGURE 11. ELECTRONICALLY COUPLED CIRCUIT WITH GROUND NOISE

3.1.7 Power supplies. The power ground and signal ground should be insulated from each other throughout the chassis to minimize the possible coupling of signals. The application of the following techniques can avoid potential problems:

- a. Use individual ground paths for ac voltages, dc voltages, and signals.
- b. Connect a ground path to the largest conductor (lowest impedance) by a direct route.
- c. Utilize several ground paths to the supply common point to maintain low ground circuit impedance.
- d. Avoid multiended ground buses or lateral ground loops.
- e. Use as few series connections (solder joints, connectors) as possible in a ground bus, and ensure that they are good, solid electrical connections.

3.2 Bonding.

3.2.1 General. A bond is an electrical union between two metallic structures used to provide a low-impedance path between them. Bonding is the procedure by which the housing or structure of a subassembly or component is electrically connected to another structure, such as the frame of an electrical machine, or chassis of an electronic assembly, in order to prevent development of electrical potentials between individual metal structures for all frequencies capable of causing interference.

3.2.1.1 Bond effectiveness. The effectiveness of a bond at radio frequencies is neither fully dependent upon nor measurable only in terms of its dc electrical resistance; especially at high frequencies, where lengths of bonding devices tend to approach the wavelengths of undesirable electromagnetic radiation. DC measurement is an indication of low-frequency bonding effectiveness. This should be accomplished with a resistance bridge. At high frequencies, however, bond effectiveness should be determined by means of impedance measurements because bond capacitance and inductance become significant and will cause high rf bond impedances, despite low dc resistance readings. The equivalent circuit of a bond strap and its impedance as a function of frequency are shown on Figure 12. In practice, dc resistance measurements are utilized to detect grossly defective bonds, and to determine quickly, by comparison with manufacturer's test data, whether or not bonds on existing equipment have deteriorated in the field. The dc resistance of an adequate bond shall be 0.0001 ohm but not exceed 0.0025 ohm.

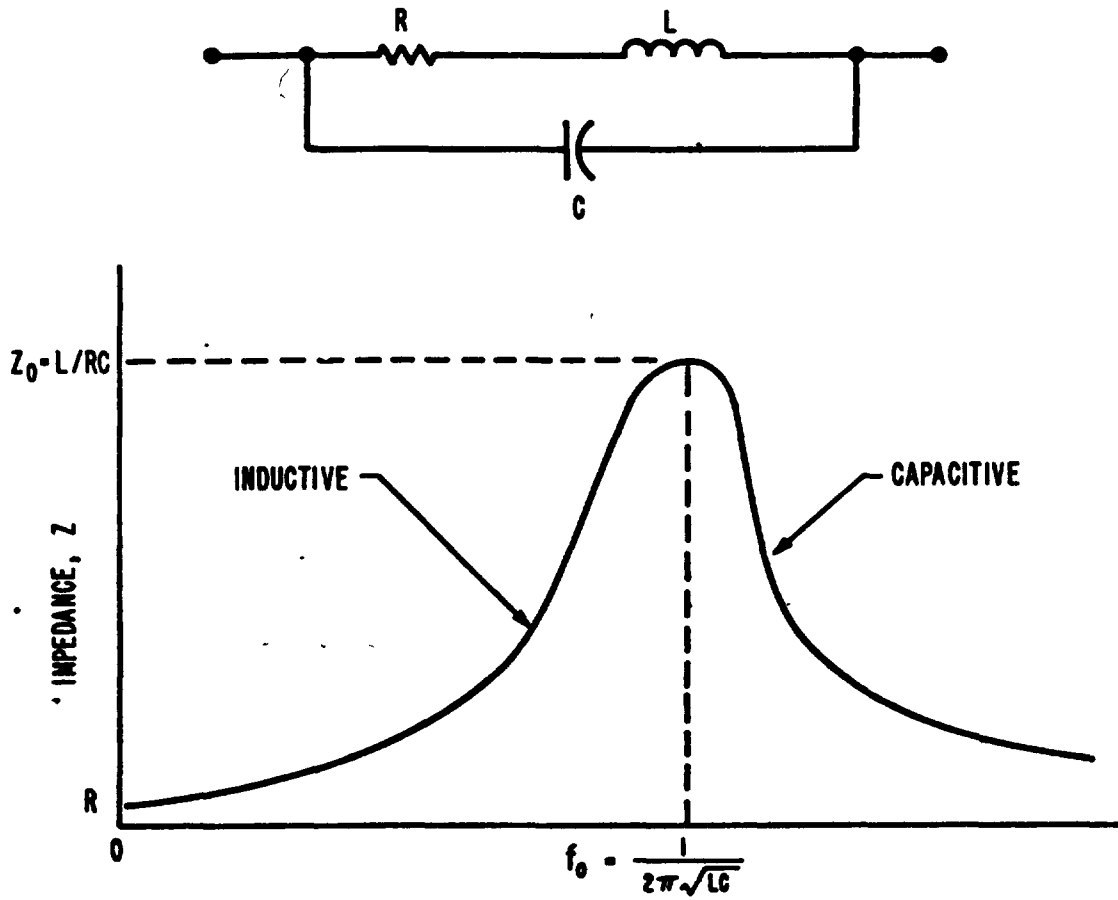

FIGURE 12. BONDING STRAP IMPEDANCE CHARACTERISTICS

3.2.1.2 Design requirements. In designing and establishing bonding criteria for specific applications, it is necessary to consider the equipment interference frequency spectrum. Of additional importance are such physical characteristics of the bonds selected as size, strength, fatigue resistance, corrosion resistance, resistivity, and temperature coefficients. The design shall provide bonds that will not deteriorate when equipment is subjected to environmental conditions as required by the equipment specification.

3.2.1.3 Bonding jumpers, (straps). Bonding jumpers should be flat, solid straps to provide large surface areas for low RF impedance (RF currents flow along conductor surfaces). The measured RF impedance of a typical flat bond-strap at frequencies up to 30 MHz increases almost linearly with frequency; such impedance is due partially to the self-inductance of the strap. The capacitance between the bonded members is in parallel with the inductance of the bond strap; and the bond strap has the characteristics of a parallel capacitance-inductance circuit. The frequency of self-resonance must be considered for at this frequency the effectiveness of the bond strap is non-existent. At higher frequencies, where length of a bond strap is an appreciable part of a wavelength, the bond strap is equivalent to an RF transmission line, and impedance can vary periodically from a minimum to a maximum with increasing frequency. When this happens, the bonding strap becomes a radiator of RF energy because it has RF current flowing through it and RF voltage across it. These effects will be avoided by keeping inductance low. Straps of high width-to-thickness ratio should be used.

3.2.2 Types of bonds. There are two classifications of bonds: direct and indirect. The most desirable of these is the direct bond. This term is applied to permanent, metal-to-metal joints such as are provided by welding or brazing. Indirect bonds are flexible metal straps, and are used when metals to be bonded cannot be placed in direct contact; for example, when there is a need for motion between bonded members.

3.2.2.1 Direct bonds. Direct bonds include permanent metal-to-metal joints formed of machined metal surfaces; or with electrically conductive gaskets held together by lock-threaded devices, riveted joints, tie rods, or pinned fittings driven tight. The direct bonded joint is formed by welding, brazing or sweating. Soldered joints should be avoided. Basic requirements for direct bonding are that metal-to-metal contact be provided and that precautions be taken to seal the joint against moisture. Dissimilar metals in direct contact should be avoided. In particular, sheet-metal type screws are inadequate for use in bonding. If two structural members are held together by screws, direct contact shall be provided.

3.2.2.2 Indirect bonds. When a direct bond is not feasible, the designer must select an indirect bond. A good indirect bond is one that presents a low impedance throughout the interference spectrum and retains its usefulness for service life of the equipment. An indirect bond is usually a bond strap or jumper, mechanically held by means of bolts, rivets, welding, brazing, or sweating. Tooth-type lockwashers are used with bolt fasteners to assure metal-to-metal contact of bondstrap connections. The most significant physical feature of a bond strap is its material and thickness. Beryllium copper or phosphor bronze are typical materials used and, under conditions of severe vibration, a corrugated strap made of these materials is recommended in preventing excessive damping and in providing desired service life. Figure 13 shows a typical bond strap bolted into position. Metal-to-metal contact at the point of bonding is required for proper operation. Corrosion shall not be allowed to compromise this requirement. Refer to MIL-F-14072A for material selection.

3.2.2.3 Bond-straps. Bond-straps must be solid, flat, metallic conductors. Solid straps are preferred because of low self-inductance. The determination of bond-strap RF impedance is obtained by using the graph of Figure 14 where the impedances of two bonding straps and of No. 12 wire are plotted against frequency. Generally, for achieving minimum bond strap inductance a length-to-width ratio of the strap should be 5:1 or less.

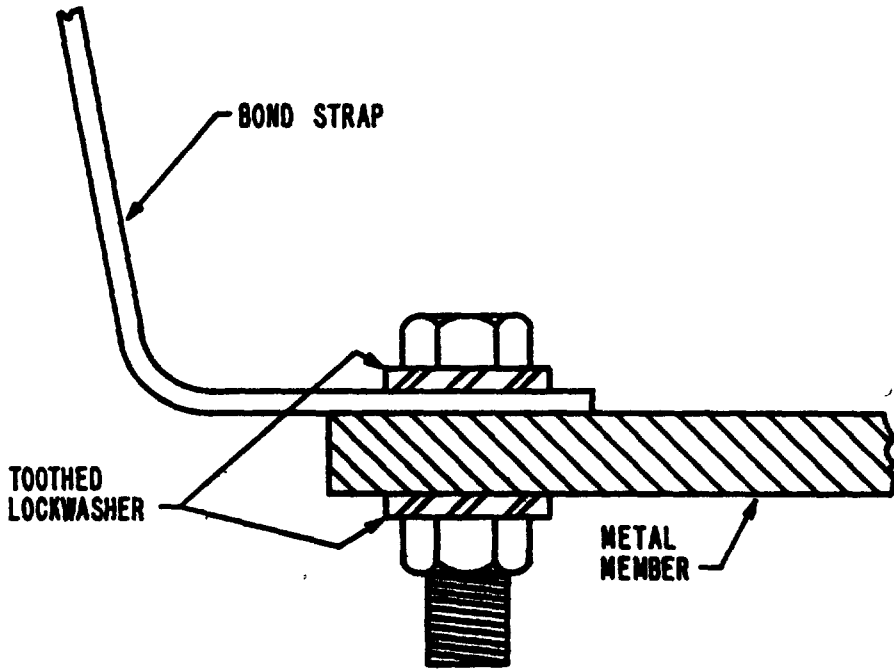

FIGURE 13. RECOMMENDED BOND STRAP BOLTING INSTALLATION

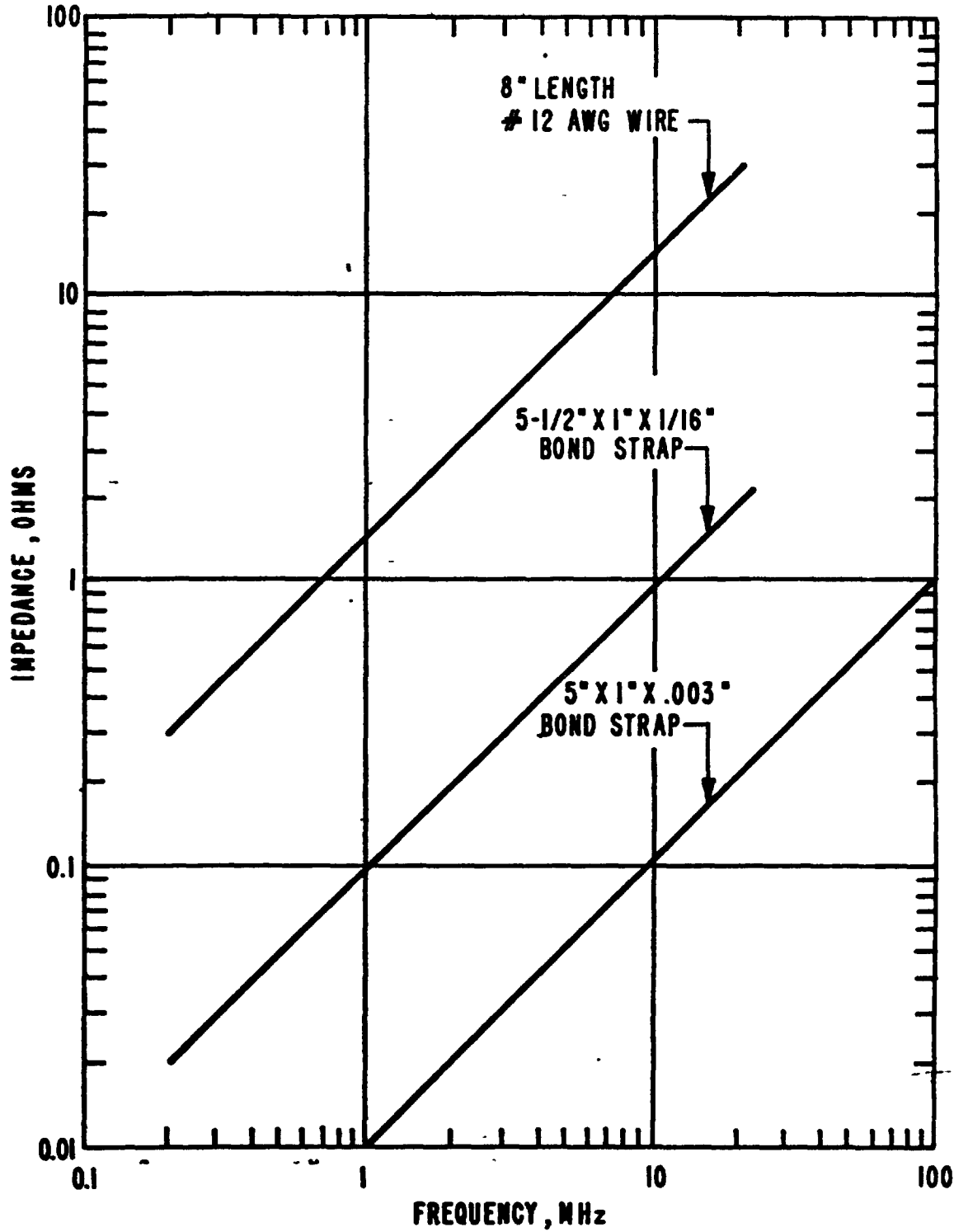

FIGURE 14. IMPEDANCES OF BOND-STRAPS AND NO. 12 AWG WIRE

3.2.3 Bonding metal selection and bond-strap finishes.

The choice of material for a given bonding application is dictated by consideration of the metals being bonded and the environment within which the bond must function. In bonding, when joining dissimilar metals, corrosion becomes an important consideration. Factors that contribute to corrosion are the proximity of metals in the electromotive series and the amount of moisture present. Corrosion is attributed to two basic electro-chemical processes: Electrolytic and galvanic corrosion. For minimizing or preventing corrosion and its adverse effects on bonding, metals low on the activity table, such as copper, lead or tin, Table I should be used. Where members of the electrolytic couple are widely separated on the activity table, plating shall be used to reconcile the dissimilarity.

TABLE I. ELECTROMOTIVE FORCE SERIES OF COMMONLY USED METALS

Metal	Electrode Potential (Volts)
Magnesium	-2.375
Beryllium	-1.700
Aluminum	-1.670
Zinc	-0.7628
Chromium	-0.740
Iron	-0.441
Cadmium	-0.402
Nickel	-0.230
Tin	-0.1406
Lead	-0.1263
Copper	+0.346
Silver	+0.7996
Platinum	+1.200
Gold	+1.420

When dissimilar metals are in contact the one with the more negative electrode potential will be more affected by corrosion. Table V of MIL-F-14072 lists groups of materials which may be used as compatible couples. Use of this table will allow a material selection resulting in the least corrosion due to galvanic action. Acceptable contact surface materials that may be used to fasten bonding jumpers to structures are indicated in Table II. The arrangement of the metals listed in this table is in the order of their decreasing galvanic activity when exposed to an electrolyte. The screws, nuts, and washers to be used in making the connections are indicated as Type I, cadmium or zinc plated, or aluminum, and Type II, passivated stainless steel. Where neither type of securing hardware is indicated, Type II is preferred from a corrosion standpoint. The possibility of electrolytic action necessitates care in designing joints that serve as bonds. Surfaces should be dry before mating, and should be held together under high pressure to minimize the possibility of moisture entering joints. Number 7/0 garnet finishing paper or equivalent should be used to remove paints, anodic films, and oxides from surfaces. The contact area should be brushed clean and should be about 1-1/2 times greater than the area necessary for actual mating. After a joint (free of moisture) is assembled, the periphery of the exposed edge should be sealed in accordance with the applicable requirements of MIL-F-14072.

3.2.4 Bonding applications.

3.2.4.1 Shock mounts. The designer should consider the degree of relative motion to be expected between two surfaces to be bonded, the characteristics of the materials involved, and the interference frequency range over which the bonding is required. A typical shock mount is shown on Figure 15. The application of a bond-strap to a vehicle engine is shown on Figures 16 and 17. The resiliency of the bonded mount should be determined by characteristics of the mount, not of the bond-strap. The strap should not dampen the shock mount. It should be corrugated to withstand severe and continued vibration. In the VHF range and higher, two bond straps across each shock mount should be used.

TABLE II FASTENERS, HARDWARE

Metal Structure (Outer Finish Metal)	Connection for Aluminum Jumper	Screw Type (Note)	Connection for Tinned Copper Jumper	Screw Type (Note)
Magnesium and magnesium alloys	Direct or magnesium washer	Type 1	Aluminum or magnesium washer	Type 1
Zinc, cadmium, aluminum and aluminum alloys	Direct	Type 1	Aluminum washer	Type 1
Steel (except stainless steel)	Direct	Type 1	Direct	Type 1
Tin, lead, and tin-lead solders	Direct	Type 1	Direct	Type 1 or 11
Copper and copper alloys	Tinned or cadmium-plated washer	Type 1 or 11	Direct	Type 1 or 11
Nickel and nickel alloys	Tinned or cadmium-plated washer	Type 1 or 11	Direct	Type 1 or 11
Stainless steel	Tinned or cadmium-plated washer	Type 1 or 11	Direct	Type 1 or 11
Silver, gold, and precious metals	Tinned or cadmium-plated washer	Type 1 or 11	Direct	Type 1 or 11

NOTE: Type 1 is cadmium- or zinc-plated, or aluminum; Type 11 is stainless steel. Where either type is indicated as acceptable, Type 11 is preferred from a corrosion standpoint.

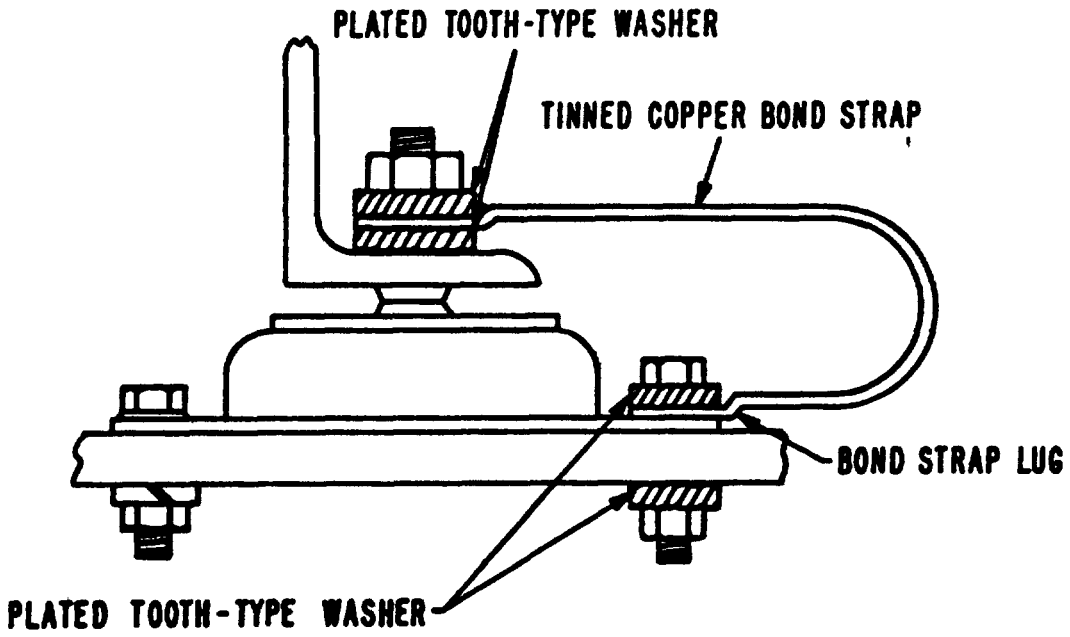

FIGURE 15. TYPICAL SHOCK MOUNT BOND

MIL-STD-1857 (EL)
30 June 1976

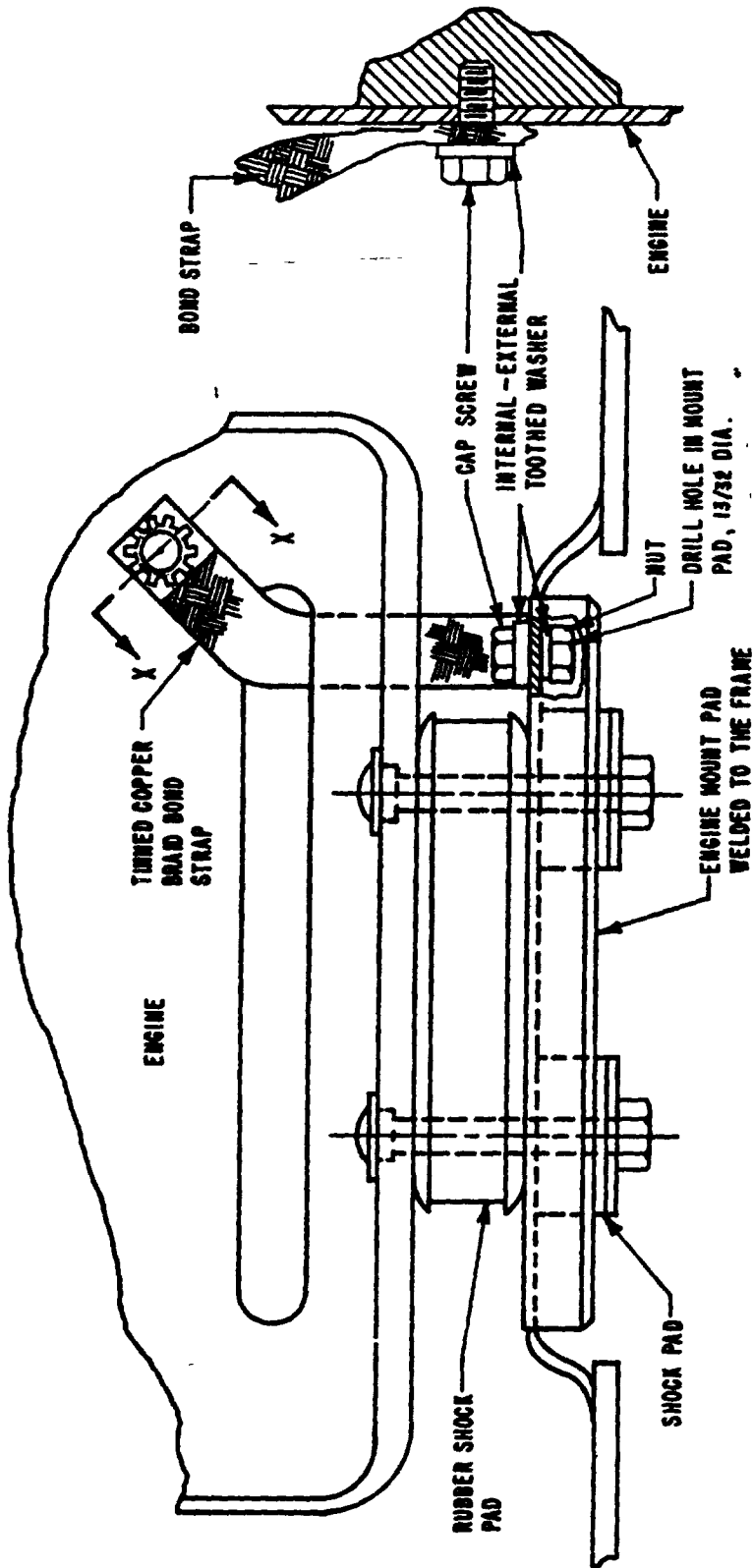

FIGURE 16. BONDED ENGINE SHOCK MOUNT - FRONT

MIL-STD-1857(EL)
30 June 1976

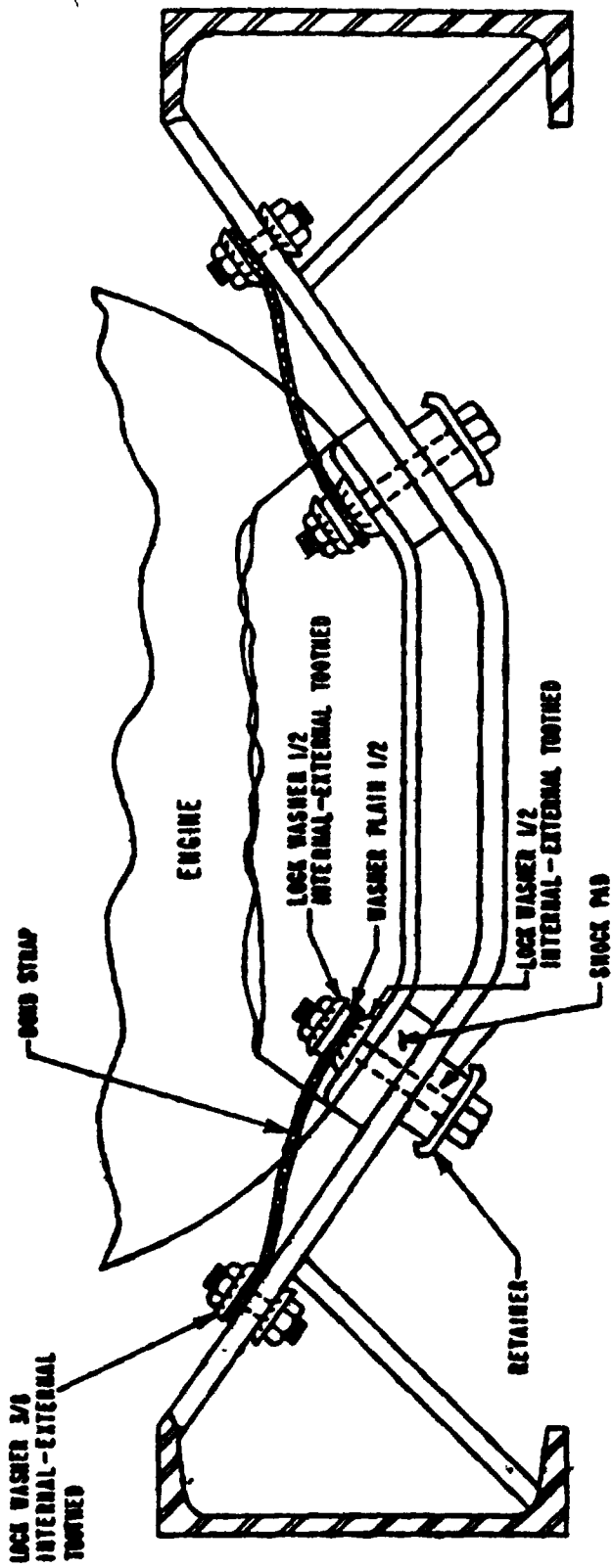

FIGURE 17. BONDED ENGINE SHOCK MOUNT - REAR

3.2.4.2 Rotating joints. It is necessary to bond shafts of rotating machinery to prevent accumulation of static charges. Bonding is generally accomplished by use of a slip ring and brush assembly, or a phosphor-bronze finger riding directly on the shaft.

3.2.4.3 Tubing conduit. The outer surfaces of long spans of conduit or shielded cable are high-impedance paths for interference currents. Such spans should be properly bonded to structures at both ends and at several intermediate points. A flared split-sleeve fitted around the flexible conduit should be used (Figure 18A). Contact shall be further improved by brazing the sleeve to the conduit through several holes in the sleeve provided for this purpose. Figure 18B illustrates a method for bonding rigid conduit to a structure through supporting attachments. The conduit or tubing, to which bonding clamps are attached, should be cleansed of paint and foreign material over the entire area covered by the clamps. All insulating finishes should be removed from the contact area before assembly only, and conductive screws, nuts, and washers should be used to attach contacting parts.

3.2.4.4 Hinges. Where hinges must be used, it is necessary to accomplish bonding by suitable means. Figure 19 shows a typical configuration for bonding hinges.

3.2.4.5 Cable trays. Cable trays should be utilized as part of the overall system bonding scheme. Each section of each tray should be bonded to the following section to provide a continuous path (Figure 20). The trays should also be connected to equipment housings by wide, flexible, solid bond-straps. A typical example of cable tray bonding is shown on Figure 21.

3.2.5 Bonding practices summarized.

a. Permanent-type bonds are more reliable than the semipermanent type, and are therefore preferred.

b. Direct-type bonds, such as formed by individual welded, sweated, or brazed joints are, in general, bonds of lower impedance than indirect types, and are therefore preferred.

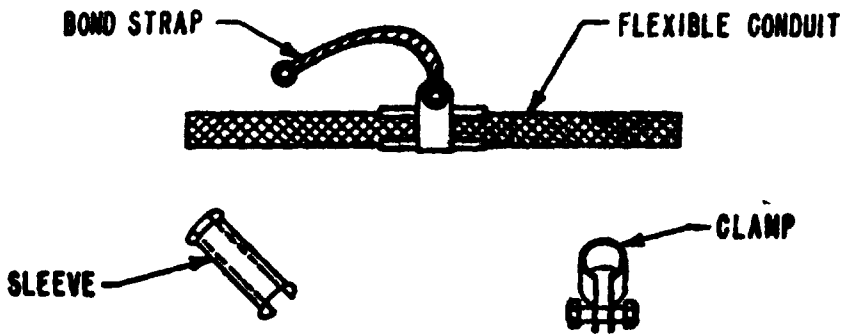

A. BONDING OF FLEXIBLE CABLE

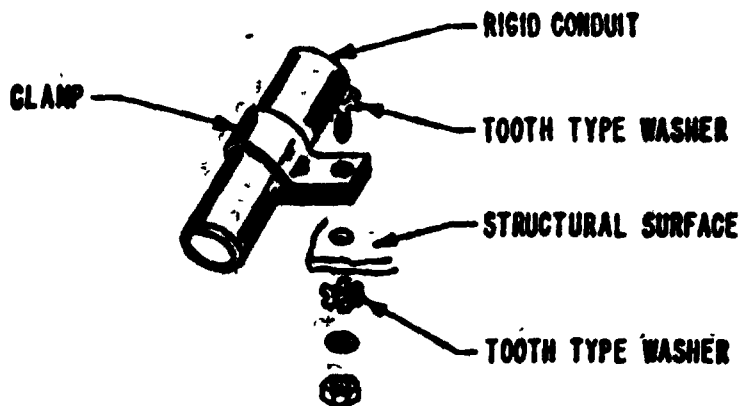

B. BONDING OF RIGID CONDUIT TO PAINTED SURFACE

FIGURE 18. CABLE AND CONDUIT BONDING

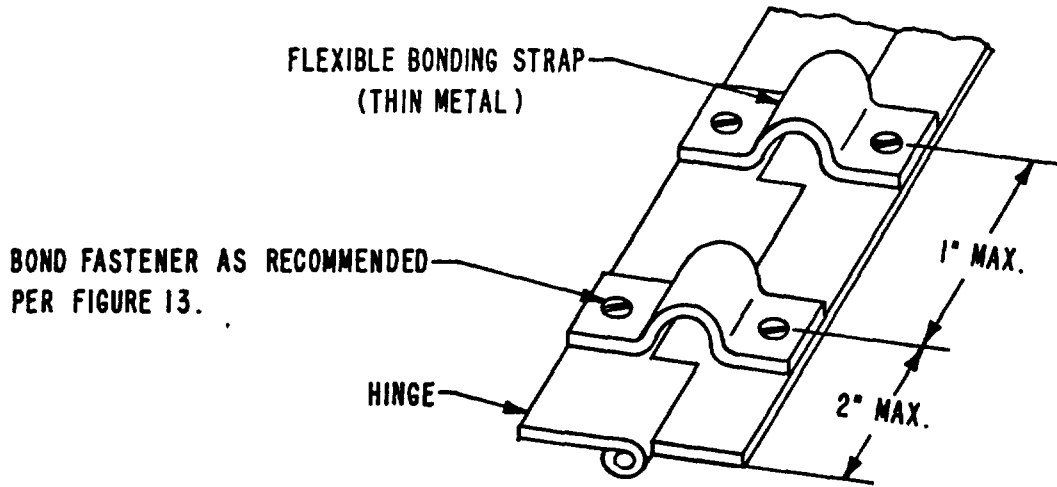

FIGURE 19. BONDING OF HINGES

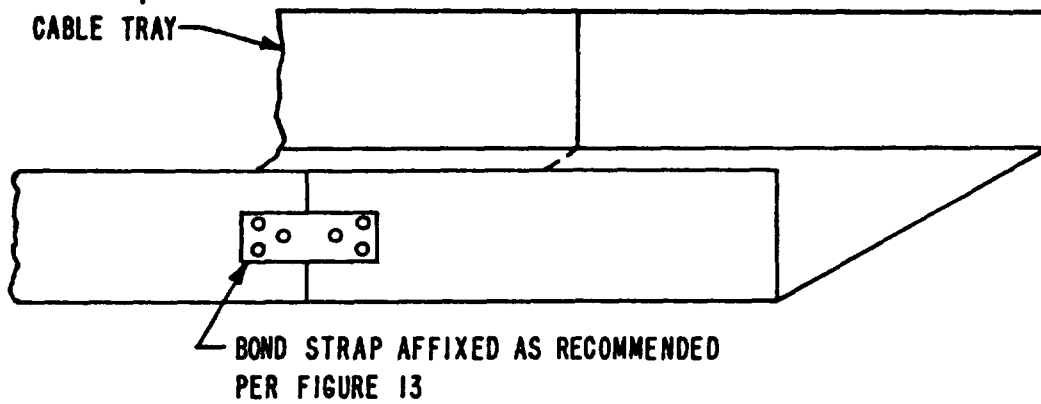

FIGURE 20. CABLE TRAY SECTION BONDING

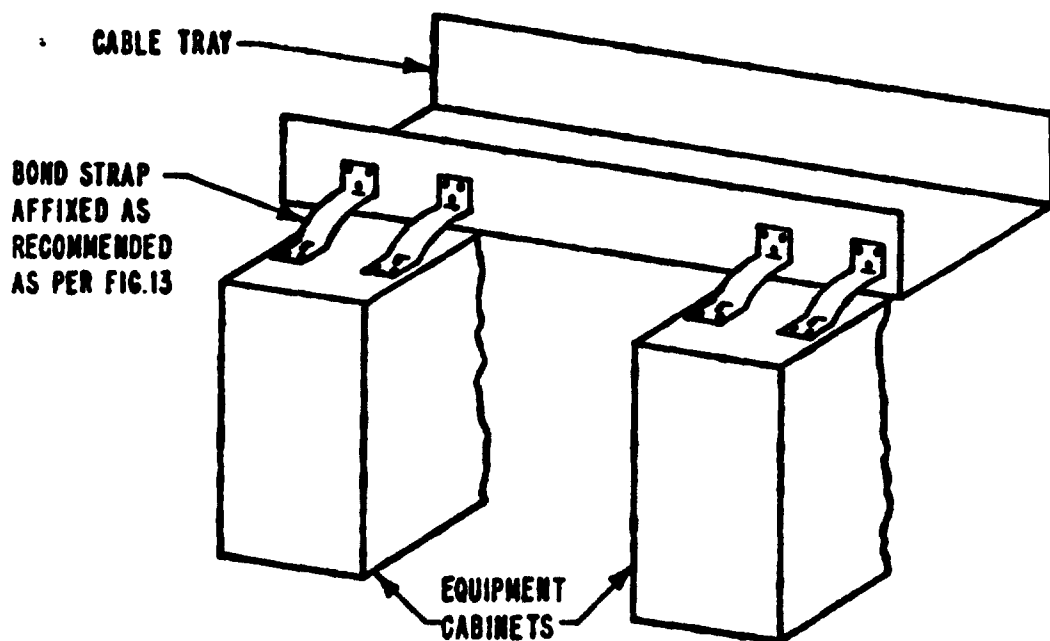

FIGURE 21. EQUIPMENT CABINETS BONDED TO CABLE TRAY

c. Bonds should afford good metal-to-metal contact over the entire mating surfaces of the bond joint. The mating surfaces should be clean and free from any nonconductive finishes. Bare, clean, metal-to-metal contact will ensure a low-impedance connection between mating surfaces.

3.2.6 Grounding requirements. A ground stud shall be provided on equipment. The ground stud shall provide the electrical ground connection to the chassis or frame and shall be mechanically secured to insure low resistance joints by soldering to a spot welded terminal lug or to a portion of the chassis or frame that has been formed into a soldering lug, or by use of a terminal by a screw, nut and lock washer. The ground stud shall be of a size to allow electrical connection of size AWG-10 wire. All hardware used for grounding or other electrical connections shall be made from copper or copper alloys. Terminal lugs shall be tin plated or hot tin dipped. Paint, varnish, lacquer, etc., shall be removed from the vicinity of the fastening point to insure metallic contact of the two surfaces. Corrosion protection shall be provided for all ground connections. Internal or external lock washers shall not be used on any grounding or other screw type electrical connections. Lock washers shall not be located between the metal plate and terminal lug or other part being grounded, so as not to interfere with the full and direct contact between these two members. Neither locking terminal lugs nor self-locking nuts shall be used for grounding. Flat washers shall be inserted next to any part having insufficient contact area with its adjacent part.

3.2.7 Earth ground.

3.2.7.1 Ground resistance. The earth can be used as a means of dissipating excessive charges caused by man-made and natural interference that may injure personnel operating equipment and damage the equipment involved. Connections to the earth, called grounds or ground connections, are made to pipes of buried water systems, driven rods, buried metal plates or buried wire. When buried pipe systems are not available, driven rods are considered the most satisfactory substitutes. Low resistance grounds are essential. Ground resistance is affected by the ground rod resistance, lead connection, contact resistance between ground rod and soil and by the type of soil. Type of soil will have the greatest affect on ground resistance. Numerous kinds of soil prevent a simple classification. Study of certain types of soil reveals a definite trend in resistivity. Soil can be roughly classified into one of the types given in Figure 22.

Type of soil	Resistance in ohms of Ground Connection (One 5-foot rod, 5/8-inch diameter)		
	Average	Minimum	Maximum
Fills, ashes, cinders, brine waste	14	3	41
Clay, shale, gumbo, loam	24	2	90
Same, with varying proportions of sand and gravel	93	6	800
Gravel, sand stones with little clay or loam	554	35	2,700

Figure 22. Soil classification chart

Temperature is another variable that affects ground resistance. There will be only a slight change in ground resistance for temperatures above 32 degrees Fahrenheit. Figure 23 shows graphically how resistance increases with decreases in soil temperature. Soils of the same type generally will differ greatly in resistance due to variations in moisture content. There is a wide variation in the moisture content of soils, from 10 percent during dry seasons to about 35 percent during wet seasons. The approximate average is from 16 to 18 percent. The effect of moisture content on resistance of soil can be seen on Figure 24.

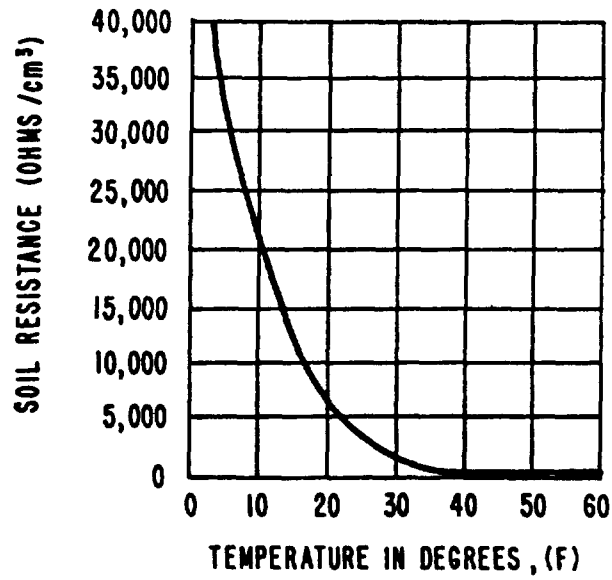

FIGURE 23. VARIATION OF SOIL RESISTANCE WITH TEMPERATURE

Moisture content (percent by weight)	Resistivity (ohms per cm cube)	
	Top Soil	Sandy Loam
0	over 1 billion	over 1 billion
2.5	250,000	150,000
5	165,000	43,000
10	53,000	18,000
15	19,000	10,500
20	12,000	6,300
30	6,400	4,200

Figure 24. Effect of moisture content on soil resistance

3.2.7.2 Grounding in sub zero zones.

Method (a)- Since a good earth ground is difficult to achieve beneath snow and ice, the following ground plane method will produce satisfactory results. Place the grounding rod usually supplied with mobile equipment, horizontally in a narrow trench in the snow as deep as possible. Extend lines of No. 6 gauge or heavier copper wire radially from the rod for about 10 feet. Use chemical aids along the rod, and cables and bury the entire system in the snow. For general effectiveness and anti-corrosion qualities, the main usable chemical aids rank as follows:

- (1) Magnesium sulphate
- (2) Copper sulphate
- (3) Calcium chloride
- (4) Sodium chloride
- (5) Potassium nitrate

Method (b) - For ground rods in soil, the depth a ground rod is driven below the surface of the earth will normally have an effect on ground resistance. Normally, resistance is relatively high at depths of less than five feet. Dig a shallow circular trench about 18 inches around the ground rod and line the trench with the chemical aids. Keep the area moist around the ground rod.

3.2.8 Separation of ac neutral from frame ground. The prime source of interfering ground currents is from ac neutral distribution through parallel frame ground paths. The solution to this problem is the isolation of all ac neutral sources from frame ground. All ac power sources within the immediate equipment area will be floated and referenced to frame ground at one point only. Power sources are defined as secondary ac transmission to any part of the equipment area to include lighting, heating, air conditioning, utility outlets, communication equipment, etc., and to the immediate equipment area. Floating a circuit is defined as closed circuit transmission using a single point as a ground reference with no dependence on earth ground or frame ground to complete any part of the neutral return path. All ac power circuits must be floated to one location. Each ac neutral shall be connected to frame or earth ground at no other

point. Ac neutral bus bars shall not be connected to the frame ground bus bars in any major item of equipment area except in one location. All power (input or interconnecting) cables (portable or transportable) shall be provided with a green insulated conductor intended only for grounding noncurrent-carrying metal parts of equipment. This equipment ground wire (EGW) shall be terminated at both ends in the same manner as the other conductors and shall be of the same size (gauge) and rating (voltage) as the other conductors. The EGW shall not be connected to the power return circuit (neutral), and the neutral wires are not to be used as EGW's. All neutral power conductors shall be white and white shall be used only for neutral power conductors. All EGW's shall be green and green shall be used for only EGW's. The following examples shall be followed:

(1) Single phase two-wire ac service

Black (hot)
White (neutral)
Green (ground)

(2) Floating single phase two-wire ac service

Grey (hot)
Grey (hot)
Green (ground)

NOTE: Ground wire is essential; 3-wire cable required.

(3) Three phase ac circuits

Black (hot) - L₁ (Phase A)
Red (hot) - L₂ (Phase B)
Blue (hot) - L₃ (Phase C)
White (neutral)
Green (ground)

NOTE: Ground wire is essential. Five wire cable for WYE connection and 4-wire cable for DELTA connection is required.

(4) Single phase three-wire ac service (such as 220 volt):

Black (hot)

Red (hot)

White (neutral)

Green (ground)

NOTE: Ground wire is essential; 4-wire cable required. Personnel safety cannot be assured if the above EGW practices are not followed. All items to be considered safe to test, to type classify or to field, must conform to the above.

3.2.9 Marine craft bonding and grounding methods. MIL-STD-1310 (Navy), entitled "Shipboard Bonding and Grounding Methods for Electromagnetic Compatibility", outlines shipboard construction and equipment installation requirements, shipboard bonding methods, and the practices necessary to minimize the electromagnetic interference (EMI) environment aboard marine craft. These requirements shall be adhered to when communication, radar, electronic and electromechanical equipments are installed in Army marine craft.

3.3 Shielding. (See Appendix For Characteristics of Material)

3.3.1 General. Shielding is required in electrical and electronic equipment to prevent the equipment from propagating interference and to protect the equipment from the effects of interference propagated by other electronic devices.

3.3.2 Shielding effectiveness. Shielding effectiveness is a measure of the ability of a material to control passage of radiated electromagnetic energy. A radiated field will be reflected and attenuated when it impinges on metal (Figure 25). This effect is analogous to the propagation of traveling waves on a transmission line. Shielding effectiveness is represented schematically on Figure 25. The mathematical relationship is depicted in Equation 1:

$$SE = R + A + B \quad (1)$$

where: SE = total shielding effectiveness (dB)

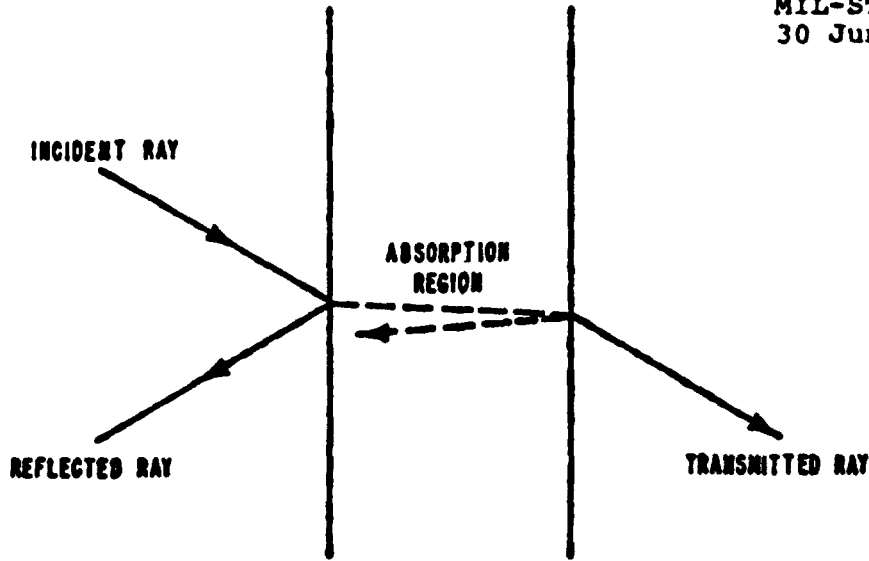

A. REFLECTION AND ATTENUATION

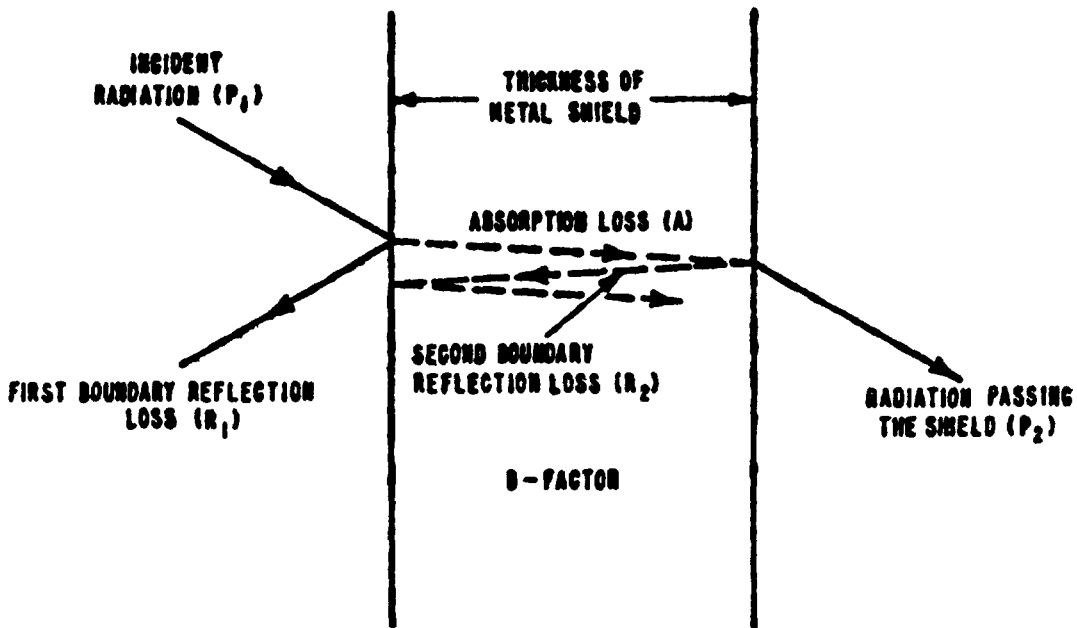

B FACTORS CONTRIBUTING TO TOTAL SHIELDING EFFECTIVENESS

FIGURE 25. METAL SHIELDING EFFECTIVENESS

$\kappa = R_1 + R_2 =$ reflection radiated power loss of the first and second boundary (dB)

A = absorption power loss (dB)

B = B-factor (dB), which is neglected if A is greater than 10 dB

P_1 = incident radiated power (dBW)

P_2 = exiting radiated power (dBW)

Expressing the conservation of energy:

$$P_2 = P_1 - R_1 - A - R_2 - B \quad (2)$$

$$P_1 - P_2 = R_1 + R_2 + A + B$$

$$P_1 - P_2 = R + A + B$$

$$SE = P_1 - P_2 = 10 \log \frac{P_1}{P_2} \quad (P_1 \text{ \& } P_2 \text{ in watts})$$

For convenience, the above equations are expressed in terms of incident power. However, at low frequencies, when operating in the induction field, it is more convenient to work with electric or magnetic field intensities. In this case (see Equation 3)

$$SE_E = 20 \log \frac{E_1}{E_2} \quad \text{and} \quad SE_H = 20 \log \frac{H_1}{H_2} \quad (3)$$

These losses are a function of frequency, thickness of material, permeability, and conductivity. The reflection losses vary with the characteristic wave impedance of the electromagnetic field and surface impedance of shield. Magnetic fields occur in the vicinity of coils or small loop antennas. Since reflection losses for magnetic fields are small for most materials, magnetic shielding depends primarily on absorption losses. Electric fields are easily obtained. The absorption loss, which is essentially independent of the wave impedance, is the same for both electric and magnetic fields. Field intensity attenuation is caused by reflection and absorption losses. The shielding effectiveness of an enclosure is the sum of the reflection and absorption losses. Absorption loss depends on the reduction in signal due to dissipation as it proceeds through the body of a shield. Reflection losses

take place at the surfaces of a shield and vary with the ratio of the wave impedance of the radiator to the surface impedance of the shield. If the absorption loss is less than 10 dB, then the B-factor must be calculated and added to Equation 1. The B-factor can be neglected when the penetration loss is more than 10 dB. Shields that contain openings, such as copper screening or incompletely welded metal seams, introduce other complexities in that signals leak through the openings. However, absorption losses can still be great if the size of the opening is small compared to the wavelength of the impinging energy.

3.3.3 Cable shielding. The most common type of shield for cables utilizes braided wire. Construction details for a typical cable shield are shown in Figure 26. The percent shield coverage may be computed by using the following relationship:

$$K = (2F - F^2) 100 \quad (4)$$

where K = coverage, %

$$F = \frac{NPd}{\sin a}$$

N = number of strands per carrier (ends)

P = picks per inch

d = diameter, carrier, single end, inches

a = angle of shield with axis of conductor, degrees

$$\tan a = \frac{2\pi(D + 2d)P}{C} \quad \pi = 3.1416$$

C = number of carriers

D = diameter of core under shield, in.

Shields for single conductors are generally constructed of wire gauge #36AWG or #34AWG. Overall cable shields may use conductors as large as #30AWG. Table III is a design guide for use in selecting shield wire size.

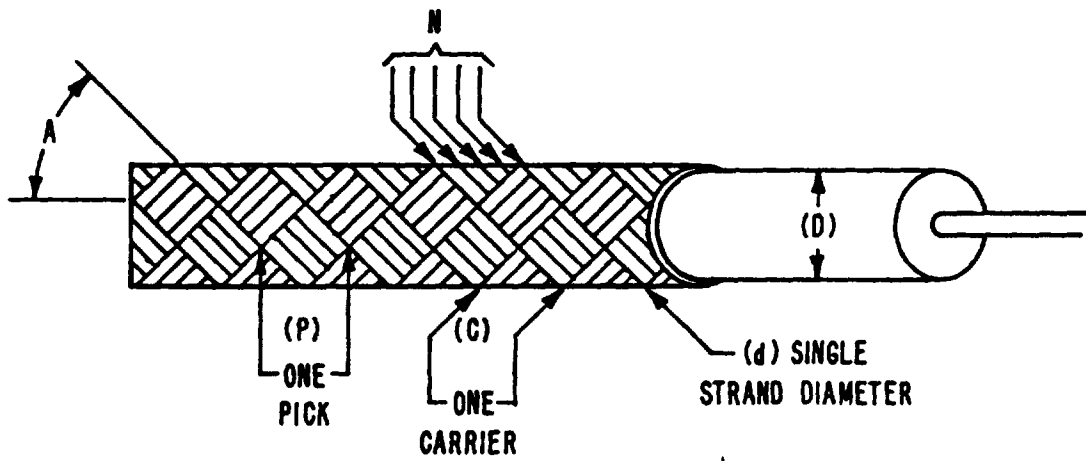

FIGURE 26 SHIELD-CONSTRUCTIONAL DETAILS

Table III. Design Guide - Shield Wire Size

<u>Diameter of Core Under Shield, in.</u>	<u>Shield Wire Size</u>
Up to 0.048	#38 AWG
0.049 to 0.300	#36 AWG
0.300 to 0.500	#34 AWG
0.500 to 1.000	#32 AWG
1.000 and over	#30 AWG

3.3.4 Case and front panel shielding. Since there are many sources of inadvertent radiation for EMC it is required that the designer provide equal shielding for each piece of equipment. To provide satisfactory shielding, an enclosure should have a shielding effectiveness sufficient to attenuate the intensity of undesired signals to the levels required to obtain maximum system/subsystem/equipment EMC and to reduce emissions to values below the equipment EMI specification requirements. All leads leaving an enclosure shall be well filtered to maintain the shielding integrity of the enclosure. An effective shield design must prevent interference energy from entering or leaving a susceptible space. Such a design will use a metal enclosure, of proper thickness, with all discontinuities such as holes, seams, and joints sealed for maximum shielding effectiveness. The value for shielding effectiveness, derived from theoretical considerations, is usually much greater than that actually obtained by measurement. This is true at high frequencies (above 100 megahertz) where the plane wave field exists because the theoretical analysis is based on the physical situation of a surface constituting a mathematical continuum -- that is, a smooth unbroken surface such as a sphere, a rectangular box, or an infinite flat plane. Surfaces of finite dimensions usually have discontinuities. These discontinuities can be treated so that they do not entirely negate the desired shielding effectiveness. At very low frequencies, the shielding effectiveness of metal sheet is small due to greater depth of interference signal penetration. SE improves as the signal frequency increases. At high frequencies, where dimensions of openings in the shield become comparable to a half wavelength, the shielding effectiveness will decrease.

3.3.5 Shielding design fundamentals. The material in this section is presented as an aid in EMC design. The terms used are defined as follows:

SE = Shielding effectiveness, representing the attenuation of incident electromagnetic energy (expressed in dB) through the metallic shield in its path. Measurements are made in power, voltage, current ratios.

R = Total reflection loss, in dB, from both surfaces, neglecting the effect of multiple reflections inside the shield.

A = Absorption loss, in dB, inside the shield.

B = A positive or negative factor that need not be taken into account when A is more than 10dB. It is caused by the reflecting waves inside the barrier, and is calculated in dB. When a metallic barrier has an A of less than 10 dB, it is designated as electrically thin (use of such barriers should be avoided).

SE = $R + A + B$, when $A < 10$ dB.

SE = $R + A$, when $A > 10$ dB.

Z_s = Intrinsic impedance of the metal

Z_w = Wave impedance of incident wave in space

μ = Relative magnetic permeability referred to free space: 1 for copper, 1 for ferrous metals at microwave frequencies, and 200 to 1000 for ferrous metals at low frequencies. (See Table IV)

μ₀ = Permeability of free space = 1.26×10^{-6} henrys/meter, which is approximately $120 \pi/C$.

ε₀ = Permittivity of free space = 8.85×10^{-12} farads/meter, which is approximately $\frac{1}{120 \pi C}$

C = Velocity of light in free space = 3×10^8 meters/second = $f\lambda$

G = Relative conductivity referred to copper. (G = 1 for copper, = 0.61 for aluminum, = 0.17 for iron) (See Table IV).

f = Frequency in Hertz

λ = Wavelength in meters

β = $2\pi f$

ω = $2\pi f$

Table IV - Values of G and μ

Frequency	Copper		Aluminum		Iron	
	G	μ	G	μ	G	μ^a
60 Hz	1	1	0.61	1	0.17	1000
1000 Hz	1	1	0.61	1	0.17	1000
10 kHz	1	1	0.61	1	0.17	1000
150 kHz	1	1	0.61	1	0.17	1000
1 MHz	1	1	0.61	1	0.17	700
15 MHz	1	1	0.61	1	0.17	400
100 MHz	1	1	0.61	1	0.17	100
1500 MHz	1	1	0.61	1	0.17	10
10,000 MHz	1	1	0.61	1	0.17	1

^aOther values of μ for iron are: 3MHz, 600;
 10 MHz, 500; and 1000 MHz, 50

- r = Distance from source to shield in meters.
- r₁ = Distance from source to shield in inches.
- t = Thickness of shield in mils
- T = Thickness of shield in meters
- E = Electric field component, or electric intensity in volts/meter
- H = Magnetic field component, or magnetic intensity in amperes/meter
- α = Attenuation constant of metal in nepers/meter
- $\sqrt{\frac{\mu_0}{\epsilon_0}}$ = Impedance of plane waves in free space = 377.6 ohms, = 120π (approximately).

Calculation of R.

$$R = 20 \log_{10} |(z_s + z_w)^2 / 4 z_s z_w| \text{ dB} \quad (5)$$

$$z_s = (1 + j) \sqrt{\mu F / 2G} \times 3.69 \times 10^{-7} \text{ ohms} \quad (6)$$

$$|z_s| = \sqrt{\mu F / G} \times 3.69 \times 10^{-7} \text{ ohms}$$

R may be zero, positive, or negative, depending upon whether the ratio given is equal to, greater than, or smaller than unity, respectively. In all cases above 1 kHz, R is positive. The corrected total reflection = R + B (algebraic sum); and may be zero, positive, or negative. In all cases above 1 kHz it is positive. B may be positive, negative, or it may equal zero, in most cases above 1 Khz, it is negative. SE is positive and always greater than zero. Total reflection loss, R, may be calculated from the following relationships for three cases:

(a) For plane waves where $r > \lambda$:

$$R = 108.2 + 10 \log_{10} G \times 10^6 / \mu F \text{ dB}$$

(b) For magnetic fields:

$$R(M) = 20 \log_{10} \left[(0.462/r_1) \sqrt{\mu/Gf} + 0.136r_1 \sqrt{Gf/\mu} + 0.354 \right] \text{ dB}$$

(c) For electric fields:

$$R(E) = 353.6 + 10 \log_{10} G/f^3 \mu r_1^2 \text{ dB}$$

Calculation of A. The absorption loss, A, can be calculated from the following relationship:

$$A = 3.338 \times 10^{-3} \times t \sqrt{Gf\mu} \text{ dB}$$

Calculation of B. This factor can be calculated from the following relationship:

$$B = 20 \log_{10} \left| 1 - \left[\frac{Z_s - Z_w}{Z_s + Z_w} \right]^2 \times 10^{-\frac{A}{10}} \right| \times (\cos 7.68 \times 10^{-4} t \sqrt{Gf\mu} - j \sin 7.68 \times 10^{-4} t \sqrt{Gf\mu}) \text{ dB}$$

When the absorption loss, A, is greater than 10dB, then the B factor can be neglected. Tables V and VI present values of absorption loss for different metals. Comparisons of various metals and magnetic materials are given in Table VI as an aid in determining the type of shield required for a particular application. Note that the absorption loss of Hypernick, at 150 kHz, is 88.5 dB per mil. To determine the SE of Hypernick, it is necessary to multiply the absorption loss by the thickness, in mils, of the Hypernick used and then add the reflection loss. It is cautioned, however, that the high permeability is useful only if the incident field is not of sufficient intensity to saturate the metal. Since magnetic materials, such as Mu-metal, have high permeability at low frequencies, and therefore high absorption loss, they are more effective as shields. The following are general rules for selection of shielding materials: Good conductors such as copper, aluminum, and magnesium should be used for high-frequency shields to obtain the highest reflection loss. Magnetic materials such as iron and Mu-metal should be used for low-frequency shields to obtain the highest absorption loss. Any metallic material will usually be thick enough for shielding electric fields at any frequency. To provide a required amount of shielding, reference to the curves of absorption loss permit quick estimates of the required metal and thickness.

Table V - Absorption Loss

Frequency	Absorption Loss (db/mil)		
	Copper	Aluminum	Iron
60Hz	0.03	0.02	0.33
1kHz	0.11	0.08	1.37
10kHz	0.33	0.26	4.35
150kHz	1.29	1.0	16.9
1MHz	3.34	2.6	36.3
15MHz	12.9	10	106.0
100MHz	33.4	26	137.0
1.5GHz	129.0	100.0	168.0
10GHz	334.0	260.0	137.0

TABLE VI. ABSORPTION LOSS OF METALS AT 150kHz

Metal	G Relative Conductivity	μ Relative Permeability (at 150kHz)	Absorption Loss (at 150kHz dB/mil)
Silver	1.05	1	1.32
Copper, annealed	1.00	1	1.29
Copper, hard drawn	0.97	1	1.26
Gold	0.70	1	1.08
Aluminum	0.61	1	1.01
Magnesium	0.38	1	0.79
Zinc	0.29	1	0.70
Brass	0.26	1	0.66
Cadmium	0.23	1	0.62
Nickel	0.20	1	0.58
Phosphor-bronze	0.18	1	0.55
Iron	0.17	1000	16.9
Tin	0.15	1	0.50
Steel, SAE 1045	0.10	1000	12.9
Beryllium	0.10	1	0.41
Lead	0.08	1	0.36
Hypernick	0.06	80,000	88.5*
Monel	0.04	1	0.26
Mu-Metal	0.03	80,000	63.2*
Permalloy	0.03	80,000	63.2*
Stainless steel	0.02	1000	5.7

*Obtainable only if the incident field does not saturate the metal

3.3.6 Multiple shielding.

3.3.6.1 General. The shielding attenuation requirements, to protect against magnetic fields are more difficult to achieve at low frequencies than at frequencies above several megahertz. Good low-frequency shields must have acceptable conductivity and high permeability. In the normal power-frequency range, copper is not practical as a magnetic shield. Mu-metal and similar type high-permeability alloys provide good shieldings for low-frequency fields; multiple magnetic shields are required dependent on strength of fields. Power transformers and audio transformers, mounted near each other, may require multiple shielding to prevent magnetic field transfer between them to minimize interference. Shielding effectiveness for electrical fields should be obtained with shields of high conductivity metal, such as copper or aluminum. Shielding effectiveness for electric (high-impedance) fields is infinite at zero frequency and decreases with increasing frequency. On the other hand, magnetic (low-impedance) fields are difficult to shield at low frequencies since reflection losses decrease toward zero for certain combinations of material. Reflection and absorption losses decrease with decreasing frequency for non-magnetic materials. At high frequencies, shielding effectiveness is good due to reflections from metal surface and dissipation of the field by penetration losses. Since much of the contribution of shielding is due to reflection loss, two or more layers of metal, separated by dielectric materials and yielding multiple reflections, will provide greater shielding than the same amount of metal in a single sheet. Copper, Mu-metal, iron, conetic and netic type materials, and other metals, some with excellent electric-field reflection loss and some with excellent magnetic field absorption-loss properties, should be used in combination. Reduce shielding effectiveness requirements for the overall equipment housing by employing suppression techniques within the equipment; for example, make use of component shields, filters at the source of the undesired signal interference, partial shields, isolation of circuits by decoupling, short leads, and the ground plane as the ground return lead.

3.3.6.2 Multiple shielding applications. For shielding to be very effective, it is necessary to employ multiple shields. An effective method of handling a cabinet cover problem by multiple shielding is shown on Figure 27A. The cover shield is in the form of a sandwich, the center of which is insulating material. The inner conducting surface of the lid makes contact with the inner side of the shield, while the outer conductor of the lid makes spring contact with the outer side of the shield. Such an arrangement is very effective. The greatest source of energy in electronic equipment is the oscillator circuit; the circuit should be enclosed in an auxiliary shield and placed inside the main shield. The entire tuned circuit, the oscillator and associated RF tuned circuits and chokes, must be placed in a separate shield that is within the main shield. As shown in Figure 27B, the inner shield must be insulated from the outer shield except for a single connection between the two. This arrangement precludes the possibility of currents circulating around a loop completed between the shields. In such an arrangement, leads passing through both inner and outer shields can be provided with additional filtering located in the space between the shields. Shafts that extend from the outside to the inner compartment must be shielded too.

3.3.7 Enclosure seam design. The design of seams requires that joints be arc welded, bolted, spot welded, or treated to produce continuous metallic contact. If a material with comparatively poor conductivity is used, the depth of material through which signals must pass should provide a shielding efficiency similar to that of the case material itself. Figure 28 illustrates a well-designed seam. Complex seams are openings that incorporate metallic folds or flanges as part of the design (Figure 29). In general, these types of seams provide better shielding efficiency than simpler types, but the efficiency obtained varies with each design.

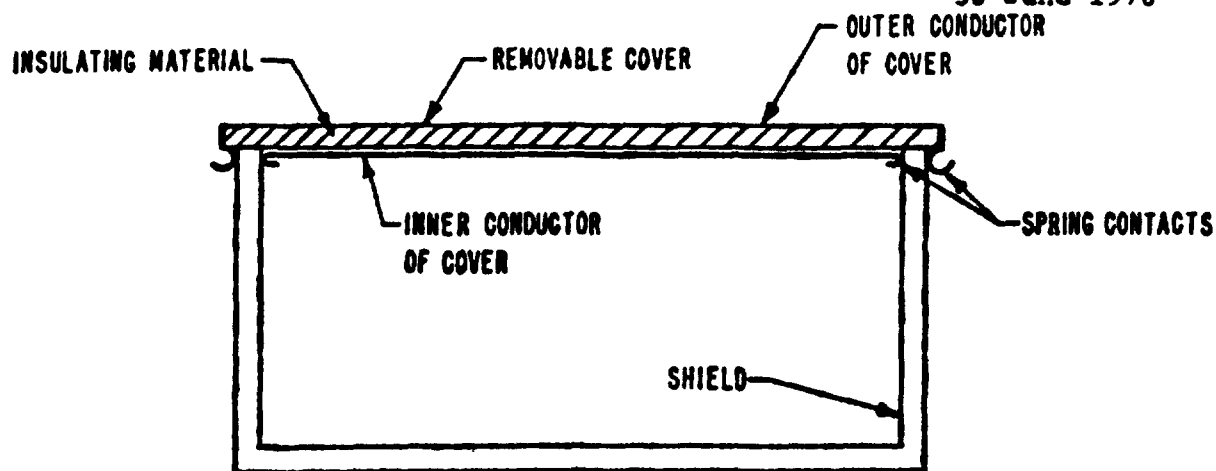

A. SANDWICH TYPE OF LID FOR A SHIELD ENCLOSURE

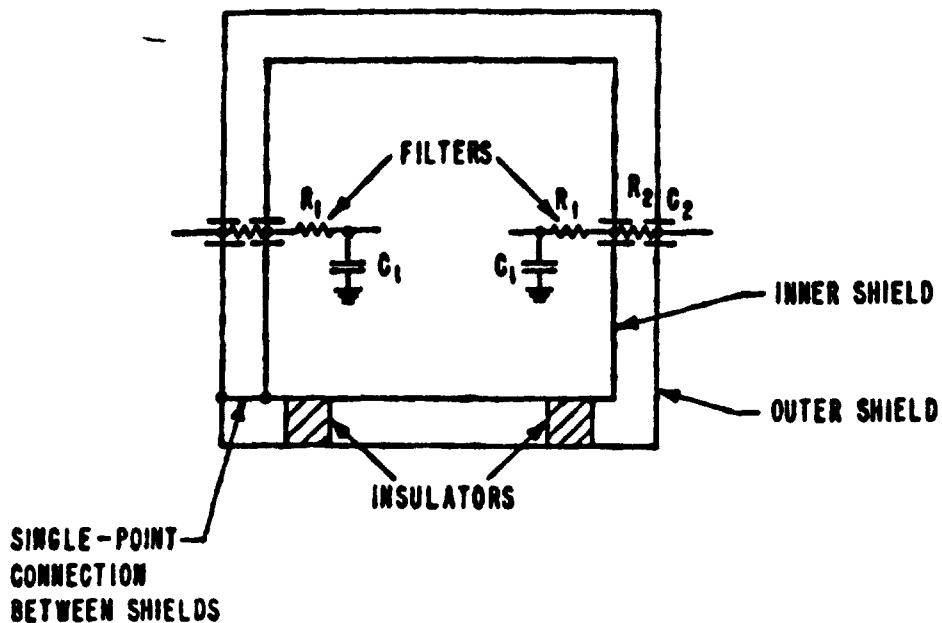

B. MULTIPLE SHIELDING SYSTEM PROVIDED WITH A SINGLE POINT CONNECTION BETWEEN THE SHIELDS.

FIGURE 27. MULTIPLE SHIELDING APPLICATIONS

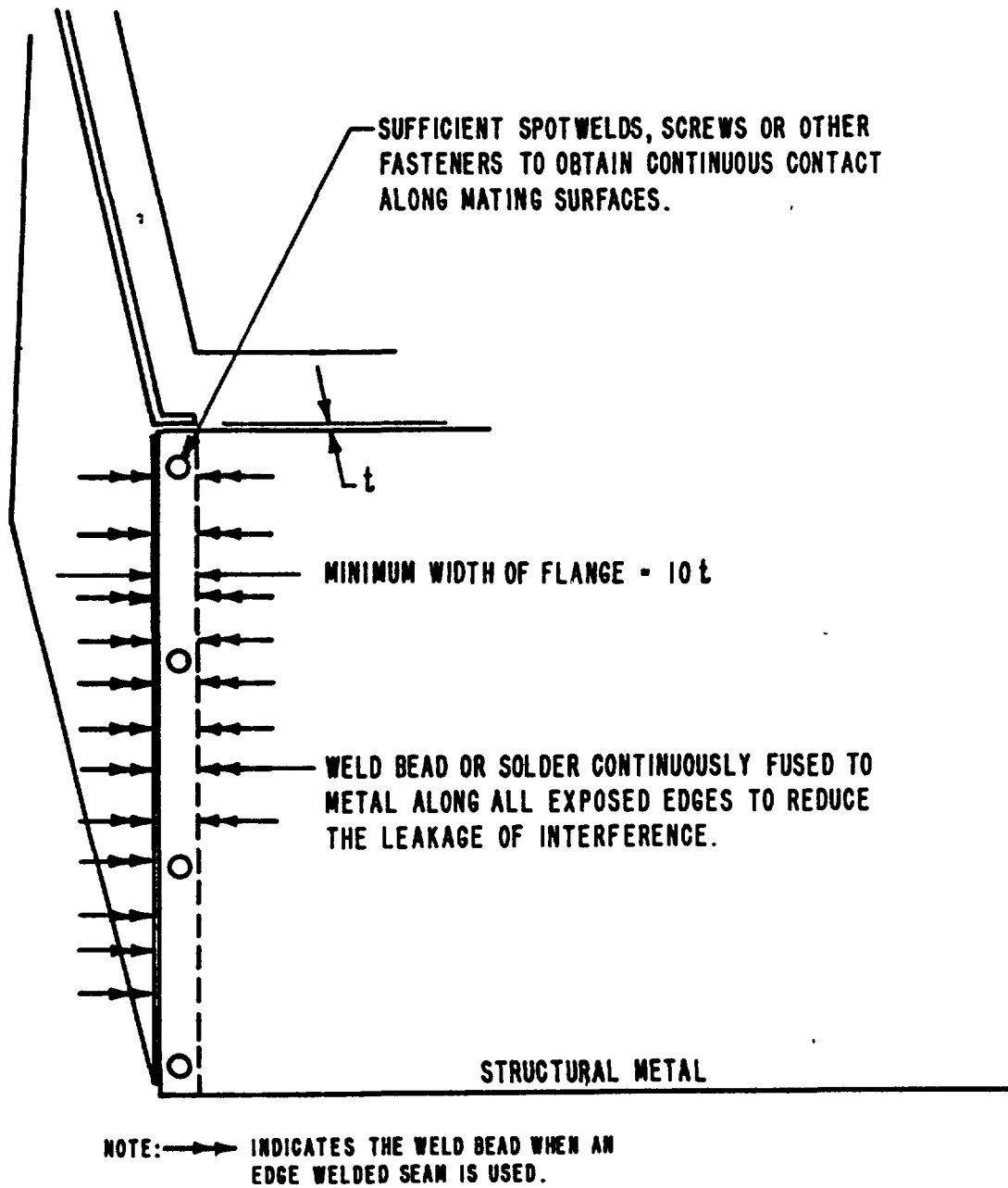
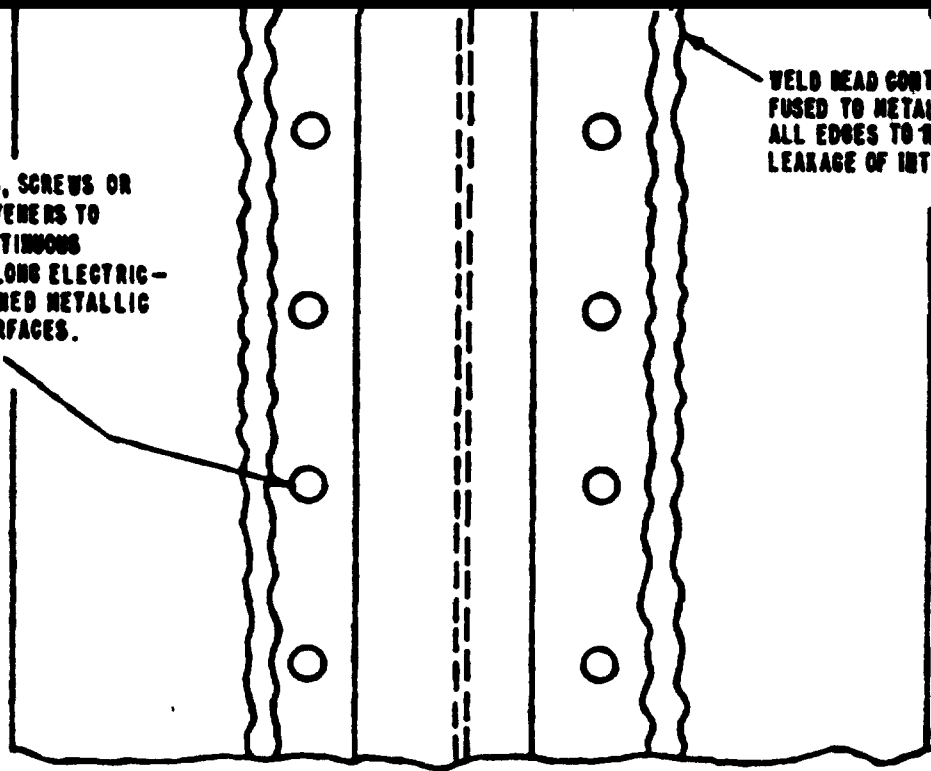

FIGURE 28. SEAM DESIGN FOR MINIMUM INTERFERENCE

SPOTWELDS, SCREWS OR
OTHER FASTENERS TO
OBTAIN CONTINUOUS
CONTACT ALONG ELECTRIC-
ALLY CLEANED METALLIC
MATING SURFACES.



WELD BEAD CONTINUOUSLY
FUSED TO METAL ALONG
ALL EDGES TO REDUCE THE
LEAKAGE OF INTERFERENCE.

FIGURE 29 VERTICAL EXPANSION JOINT, AN EXAMPLE OF A COMPLEX SEAM

3.3.8 Screening. An equipment enclosure that requires inlet and/or outlet apertures should be designed with a screen or a series of honeycomb tube ducts (designed to act as waveguide below cutoff devices) placed over the ventilation apertures. In descending order of attenuation properties, the following materials should be used: honeycomb-type ventilation panels, perforated metal sheet, woven metal mesh, and knitted metal mesh. The honeycomb material has the advantage of low air resistance (Figure 30 and 31). The honeycomb ventilation material is shown on Figure 32.

3.3.9 Shielding of apertures.

3.3.9.1 General. Electromagnetically, a small aperture is one which is small in its largest dimension than a signal wavelength. An aperture approaching or exceeding a wavelength in size must be covered by a fine mesh copper screen. Alternatively, a series of small unscreened apertures may be used instead of a single large hole; or waveguide attenuators may be used to shield large apertures. Waveguide attenuators can be designed to provide over 130 decibels of attenuation. The waveguide attenuator is also of considerable value when control shafts must pass through an enclosure. When an isolated control shaft passes through a waveguide attenuator, the control function can be accomplished with almost no interference leakage. In many cases, shielding screens introduce excessive air resistance, and sometimes greater shielding effectiveness may be needed than they can provide. In such cases, openings may be covered with specially designed ventilation panels (such as honeycomb) with openings that operate on the waveguide-below-cutoff principle. A sample panel is shown on Figure 32. Honeycomb-type ventilation panels in place of screening:

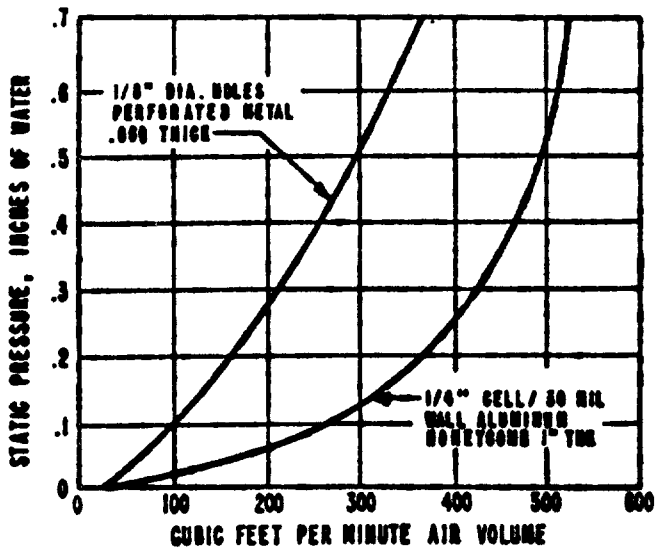

FIGURE 30. AIR IMPEDANCE OF PERFORATED METAL AND HONEYCOMB

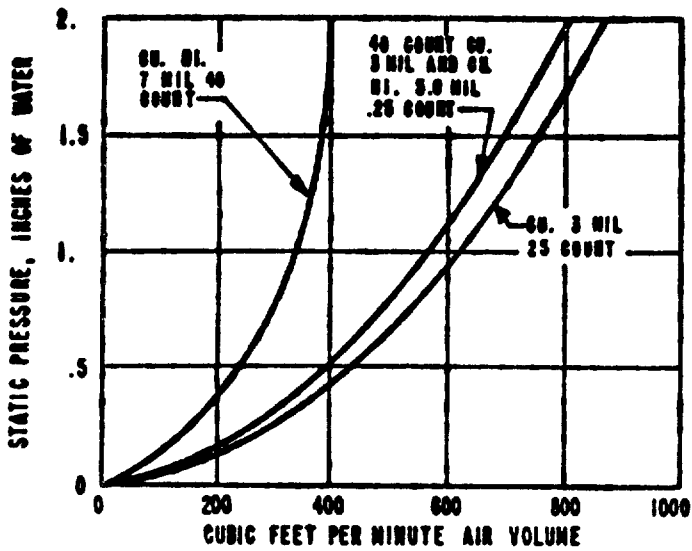

FIGURE 31. AIR IMPEDANCE OF COPPER AND NICKEL MESH

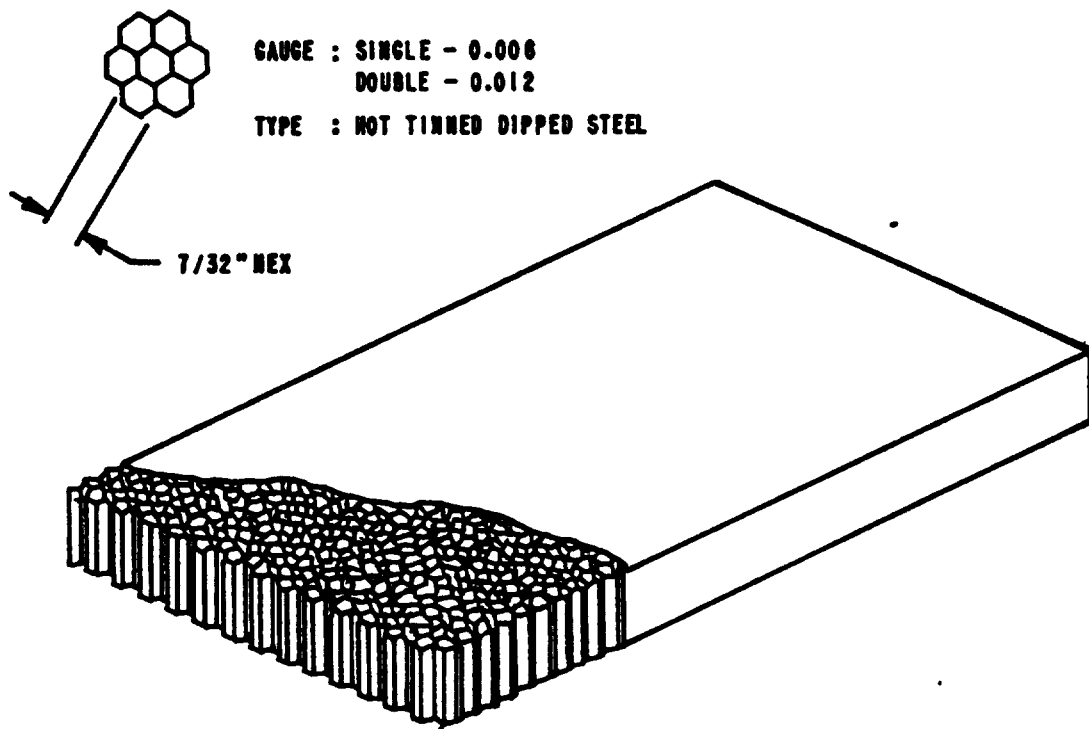

FIGURE 32. HONEYCOMB TYPE VENTILATION PANEL

a. Allow higher attenuation than can be obtained with mesh screening over a specified frequency range,

b. allow more air to flow without pressure drop for the same diameter opening,

c. cannot be damaged easily as can the mesh screen, and are therefore more reliable,

d. are less subject to deterioration by oxidation and exposure. All nonsolid shielding materials, such as perforated metal, fine mesh copper screening, and metal honeycomb, present an impedance to air flow. Metal honeycomb is the best of these materials because it enables very high electromagnetic field attenuation to be obtained through the microwave band with negligible drops in air pressure. Panels of honeycomb vary in thickness from 3/4 inch to 2-3/8 inch, depending upon the attenuation desired. Honeycomb panels can achieve attenuations to 136 dB, above 10 MHz. Screened openings must usually be large to permit sufficient air flow. When frequencies above 1000 MHz are to be attenuated to a high degree, ventilation openings must be designed as waveguide attenuators operating below cut-off at their lowest propagating frequency. In this manner, shielding effectiveness of over 100 dB can be obtained at frequencies of 10 GHz: a 1/4 inch diameter tube, 1 inch in length, would have 102 dB of shielding effectiveness at 10 GHz; a 1/2 inch diameter tube, 2 1/4 inches long, 100 dB of shielding effectiveness at 10 GHz. Openings 1 inch or more in diameter would have little or no attenuation at 10 GHz. To obtain an opening of sufficient size to admit the required volume of ventilating air, tubes should be placed side by side until sufficient air flow is achieved.

3.3.9.2 Waveguide attenuation characteristics. The action of the waveguide operating below cut-off frequency (when it is used at a wavelength greater than its cutoff wavelength) is represented on Figure 33 for a rectangular waveguide, and Figure 34 for a circular waveguide, both for a $\frac{D}{W}$ ratio of 1. When the

ratio is not 1 in a particular design problem, the value in decibels, obtained from the curve, must be multiplied by $\frac{D}{W}$ to ar-

rive at the correct value of attenuation. The equation for the rectangular waveguide attenuator is:

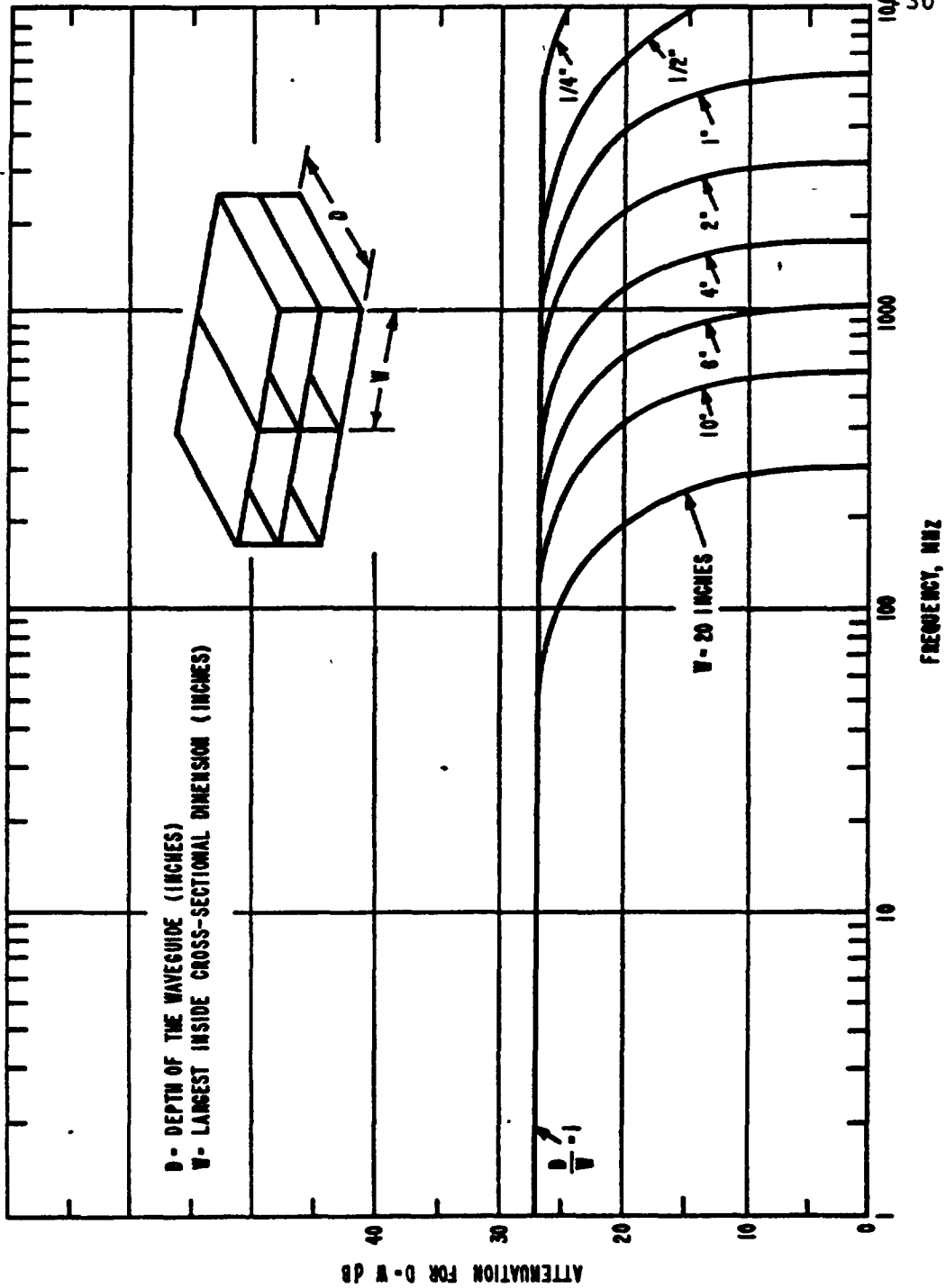

FIGURE 33. ATTENUATION - RECTANGULAR WAVEGUIDE

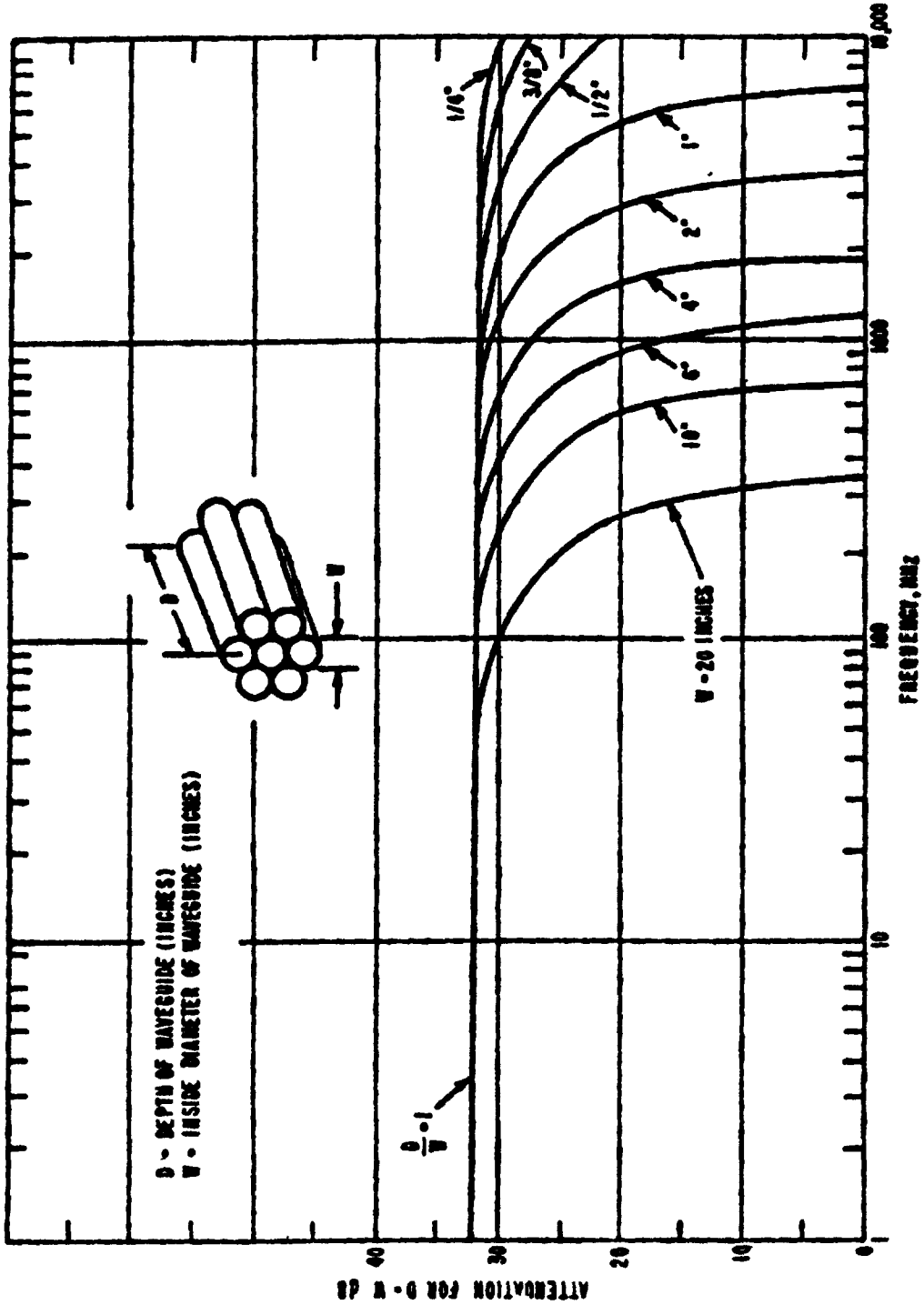

FIGURE 34. ATTENUATION-CIRCULAR WAVEGUIDE

$$A = 27.3 \frac{D}{W} \sqrt{1 - \left(\frac{Wf}{5910}\right)^2} \text{ decibels} \quad (7)$$

where: D = depth of the waveguide in inches
W = largest inside cross-sectional dimension, in inches
f = frequency in megahertz

For a rectangular waveguide, to determine the depth required for 100 dB attenuation at 1000 MHz when the largest cross-sectional dimension is 0.125 inches:

$$\begin{aligned} A &= 27.3 \frac{D}{W} \sqrt{1 - \left(\frac{Wf}{5910}\right)^2} \text{ decibels} \\ \frac{A}{D} &= \frac{27.3}{W} \sqrt{1 - \left(\frac{Wf}{5910}\right)^2} \frac{\text{decibels}}{\text{inch}} \\ &= \frac{27.3}{(.125)} \sqrt{1 - \left[\frac{(.125)(1000)}{5910}\right]^2} \\ &= 218 \frac{\text{db}}{\text{inch}} \end{aligned} \quad (8)$$

To obtain 100 dB attenuation:

$$\begin{aligned} \frac{100 \text{ dB}}{D} &= 218 \frac{\text{dB}}{\text{inch}} \\ D &= \frac{1 \text{ inch}}{218 \text{ dB}} ; 100 \text{ dB} = \frac{1}{2} \text{ inch} \end{aligned} \quad (9)$$

The equation for a circular waveguide attenuator is:

$$A = 31.95 \frac{D}{W} \sqrt{1 - \left(\frac{Wf}{6920}\right)^2} \text{ decibels} \quad (10)$$

where: D = depth of the waveguide in inches
W = inside diameter of waveguide in inches
f = frequency in Megahertz

These waveguides function as high-pass filters. All frequencies below the cutoff frequency are attenuated. The lowest cutoff frequency in megahertz for rectangular and circular waveguides are respectively:

$$f = \frac{5910}{c} \quad \text{Longest dimension of rectangle} \quad (11)$$

and

$$f = \frac{6920}{c} \quad \text{diameter of circular opening} \quad (12)$$

where f is in MHz, and the dimensions are in inches.

The maximum operating frequency should be 1/10 of the cutoff frequency. Although the attenuation is near maximum at 1/3 cutoff frequency, the 1/10 value is advisable to provide a safety factor. In the waveguide, the attenuation-per-unit length for an operating frequency, f (in MHz) below the cutoff frequency of the waveguide is:

$$\alpha = \text{dB/inch of sleeve length} = 0.00463 f \sqrt{\left(\frac{f}{c}\right)^2 - 1} \quad (13)$$

Figures 33 and 34 indicate the frequency range over which any particular opening is useful. The conductivity and electrical thickness of the metal walls between openings is sufficient at frequencies as low as 1 MHz. The flat characteristics of the curves continues to the lowest frequency at which this condition is met. The waveguide-below-cutoff approach is recommended as a more reliable method of shielding, with higher attenuation and minimum air pressure drop. Control shafts, that protrude through a hole in a shielded equipment enclosure, can be of metal, grounded by metallic fingers, or be of nylon, teflon, or other dielectrics inserted through the metallic tube or shield waveguide (figures 35 and 36). The waveguide approach should be considered where holes must be drilled in an enclosure. If the metal thickness is sufficient to provide a tunnel with adequate length, it will effectively serve as a waveguide attenuator. For example, a metal wall 3/16 inch thick would permit a 1/16 inch diameter hole to be used without excessive leakage. This approach should be considered where it is necessary to confine intense interference sources.

3.3.10 Fasteners. To provide correct contact between mating metallic surfaces, sufficient fasteners must be used and, care must be taken to avoid buckling between the surfaces. The spacing between fasteners must be much closer as the materials become thinner because of bending under pressure (Figure 37). The

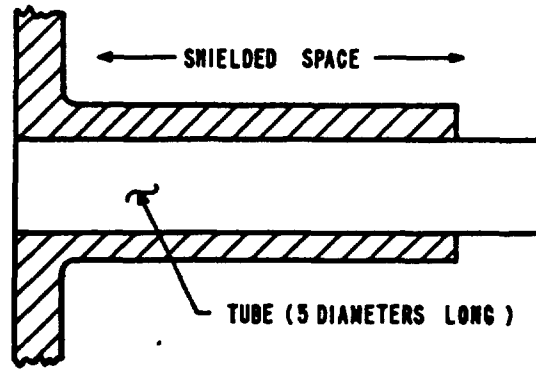

FIGURE 35. TUBE ACTING AS WAVEGUIDE ATTENUATOR

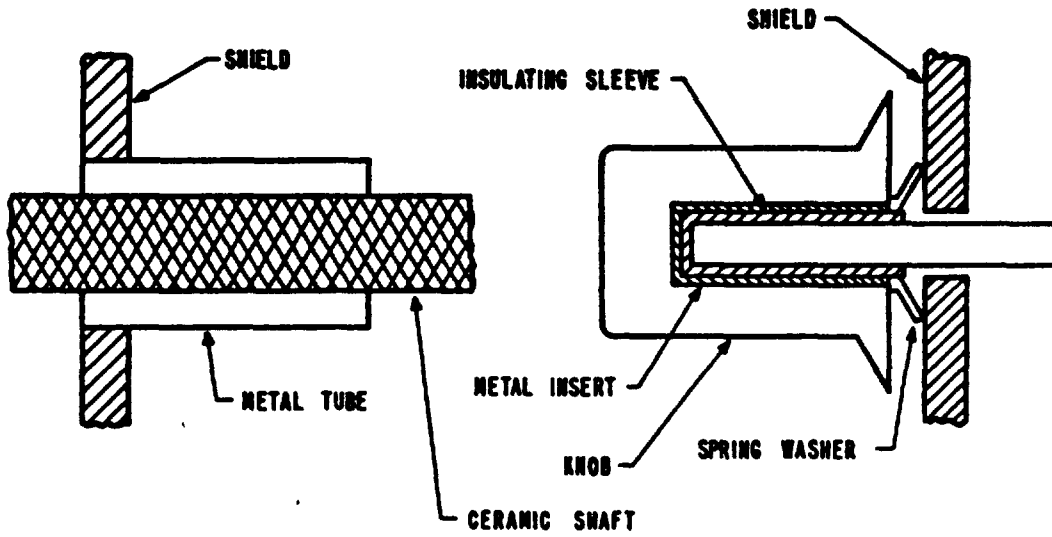

FIGURE 36. SHAFT FEEDTHROUGH TECHNIQUES

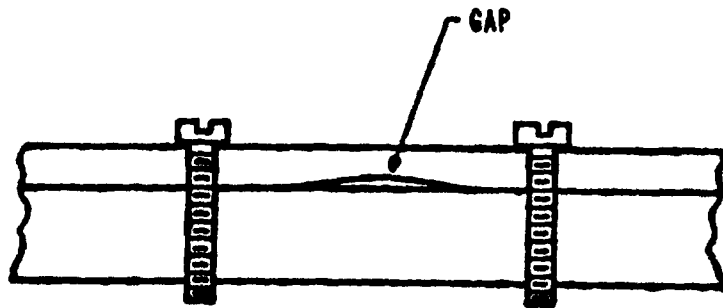
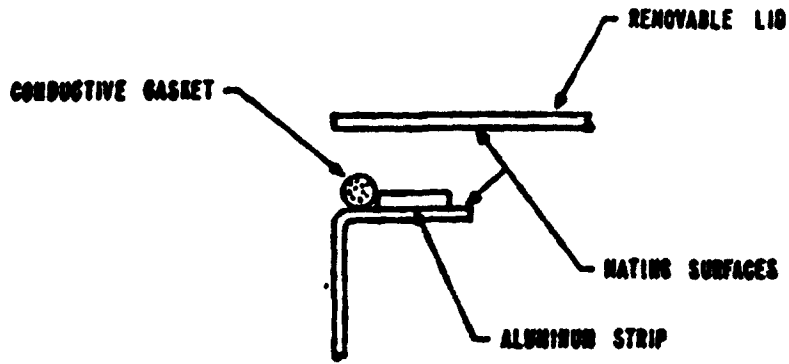
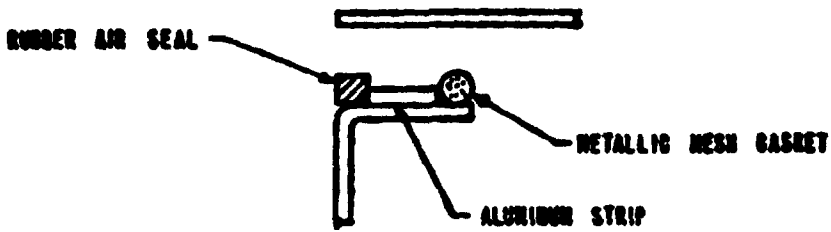

FIGURE 37. BUCKLING BETWEEN FASTENERS WITH THIN MATERIAL

spacing of the fasteners should prevent RF leakage when the metal surfaces spread apart as a result of vibration or misalignment. In addition to shielding against interference, it is often necessary to provide an air seal at equipment seams. A method of achieving this is shown on Figure 38.



A. GASKET APPLICATION



B. COMBINATION GASKET FOR AIR PRESSURE AND RFI SEAL

FIGURE 30. SEAM TREATMENT WITH MESH GASKETS

3.3.11 Conductive gaskets.

3.3.11.1 General. When it is necessary to join several parts of a complete shield, the first consideration should be to minimize the number of joints. When joints are made, continuous metal-to-metal contact must be maintained along a continuous line. When the pressure is maintained by screws or bolts, a sufficient number must be used to ensure high unit pressure even at the points farthest away from any screw or bolt. Lack of stiffness of mating members produces distortion of mating surfaces, which results in bulging and insufficient pressure for preserving good electrical contact (Figure 39). The design of these joints can be simplified by employing conductive gaskets. There are two types of compressible gaskets: the flat (Figure 40) gasket and the groove gasket. The groove gasket is installed as shown on Figure 41. Joints with insulating groove gaskets should be utilized to allow for metal surfaces making contact between the bolt holes. The volume of the groove must be greater than the volume of the gasket. Because practically all electronic equipment must be designed with seams or openings to facilitate inspection, cooling, data output metering, tuning, or other functions, and because these seams or openings usually represent the weakest points in the overall shield design, shielding must be provided to prevent entry or exit of interfering electromagnetic energy. In sealing such items as seams and panel joints to interference, conductive gaskets are required to ensure continuous low-impedance contact between mating metal surfaces.

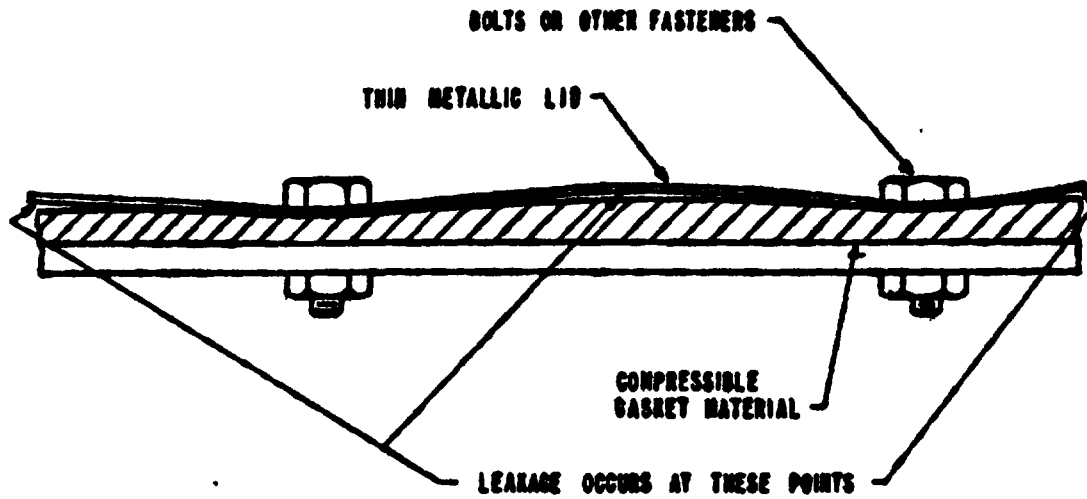

NOTE: VIEW PURPOSELY EXAGGERATED TO DEMONSTRATE IMPERFECT SEAL CONDITIONS

FIGURE 39. IMPROPER GASKET APPLICATION

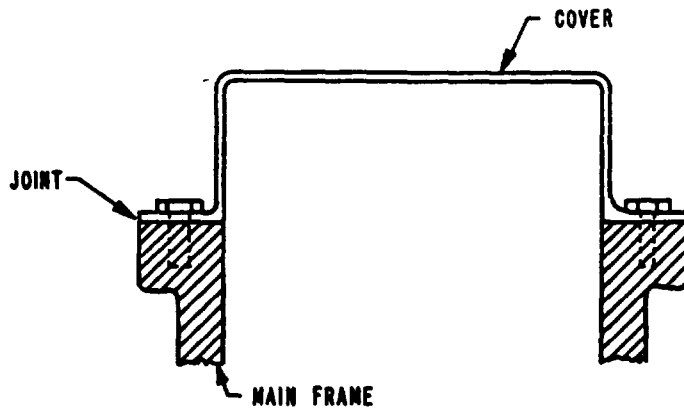

FIGURE 40. FLAT-FLANGE TYPE JOINT

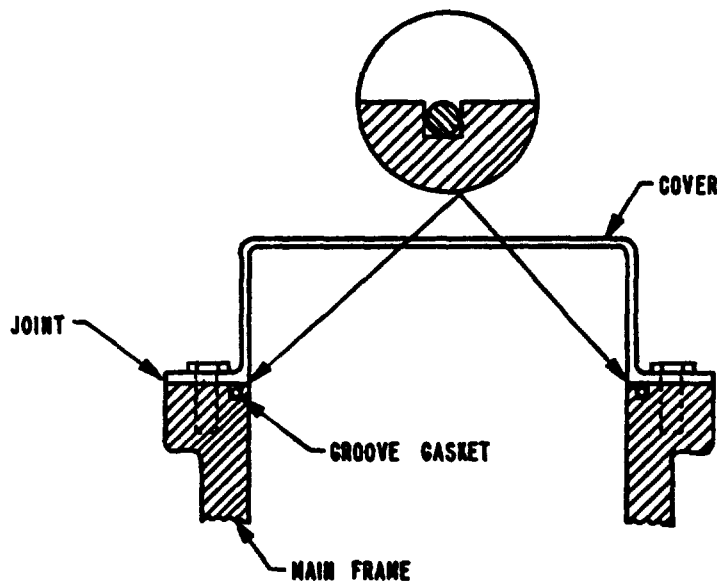

FIGURE 41. FLAT-FLANGE TYPE JOINT WITH GROOVE GASKET

3.3.11.2 Application. For satisfactory assembly, a gasket should be retained in a slot or a groove. Figure 42 illustrates arrangements for use of this type of gasket in a flange and cover-plate joint. Typical closures using resilient conductive electronic weather strips are depicted on Figure 43. In designing gaskets, it is necessary to provide minimum gasket thickness to allow for surface discontinuities of the joint; to provide correct height and pressure; and to allow for frequency of flexure. The gasket materials selected should be corrosion resistant, conductive, resilient and meet requirements of MIL-STD-810. Gaskets must be held in place by sidewall friction, an attachment fin, or positioned by a shoulder as shown on Figure 44. Gaskets of various configurations are shown on Figure 45.

3.3.11.3 Fastening materials. Figure 43 shows several ways that various forms of strip materials can be held in place. Two methods predominate: the use of an attachment fin and sidewall friction in a slot. In the sketches on Figure 44, the gasket shown should be spot-welded directly or held by bonding cement. The bonding compound should be applied in small 1/8 inch diameter droplets, every one or two inches, or as continuous thin strip on wider materials.

3.3.11.4 Equipment panels. Figure 46 illustrates a typical conductive gasketing problem: an equipment panel sliding into a case with an internal flange. If the panel also holds the chassis, then the entire weight of the equipment, exclusive of the case, is borne by the flange, therefore, it is very desirable that there be a rigid, positive stop on any gasketing material used in the joint between the panel and case flange. The gasket shown is ideally suited for this application; it has an aluminum extrusion to which is attached a resilient gasketing material. The panel comes to a stop at the thickness of the extrusion. Because the uncompressed thickness of the material is larger than the thickness of the extrusion, it operates under pressure.

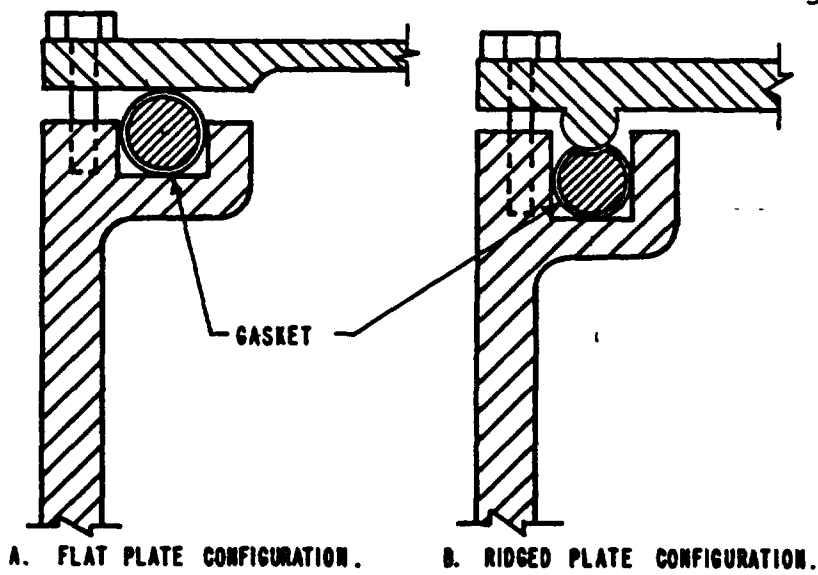

FIGURE 42. TYPICAL GROOVE TYPE GASKET APPLICATIONS

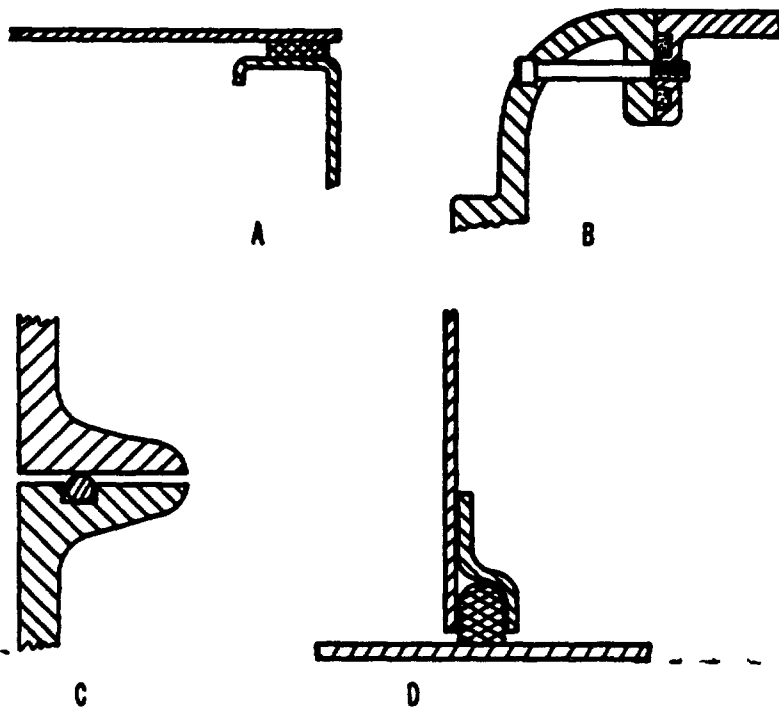
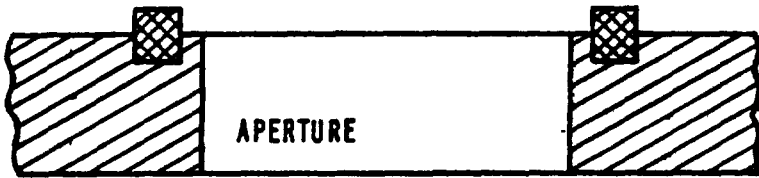
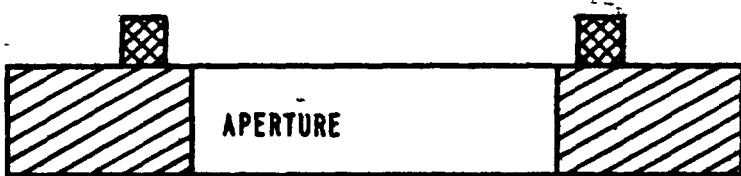

FIGURE 43. TYPICAL CONDUCTIVE GASKET APPLICATIONS



A. HELD IN PLACE IN SLOT BY SIDE-WALL FRICTION



B. HELD IN PLACE BY SOLDERING (AMOUNT OF SOLDER USED MUST BE CAREFULLY CONTROLLED TO PREVENT ITS SOAKING INTO THE GASKET)



C. POSITIONED BY SHOULDER

FIGURE 44. TYPICAL GASKET MOUNTING METHODS

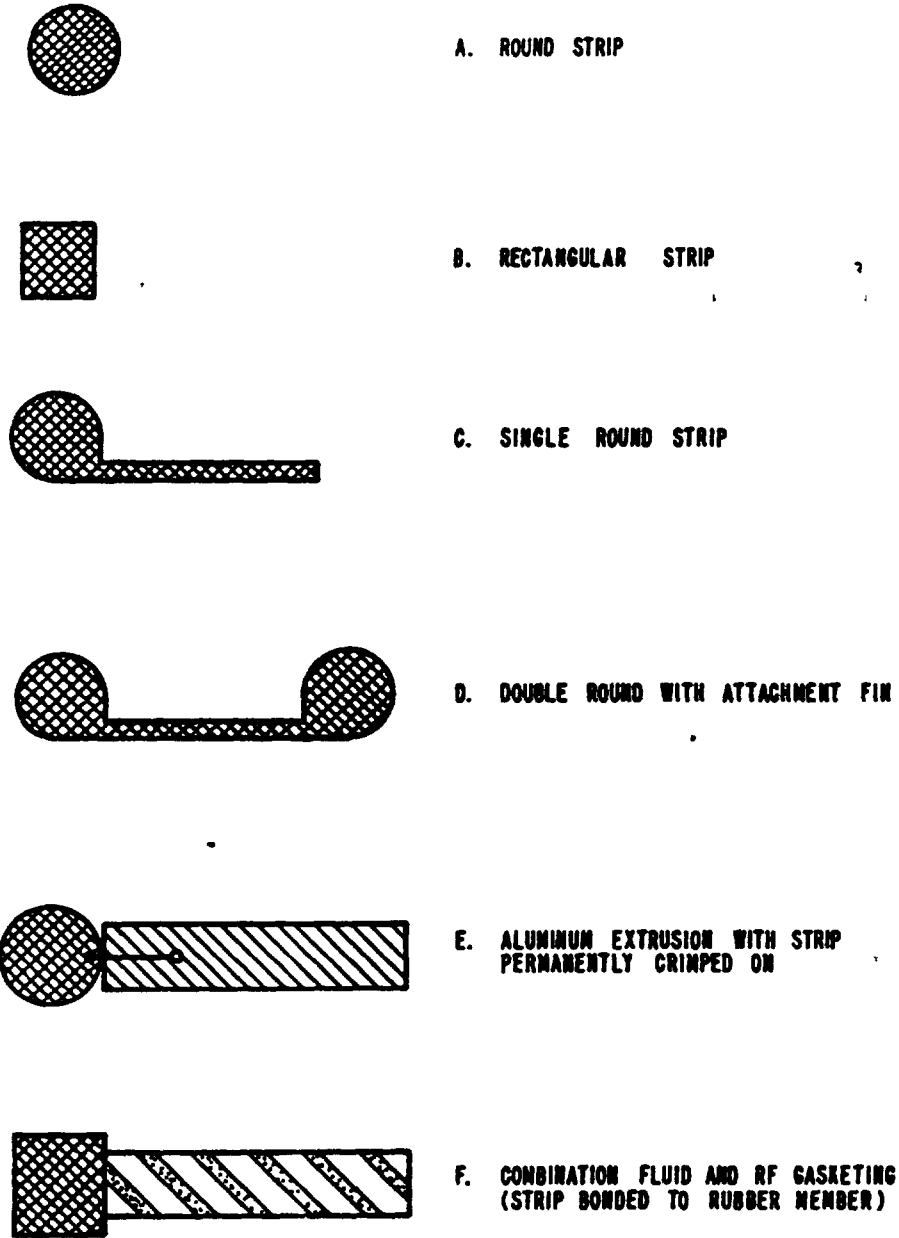

FIGURE 45. VARIOUS GASKET CONFIGURATIONS

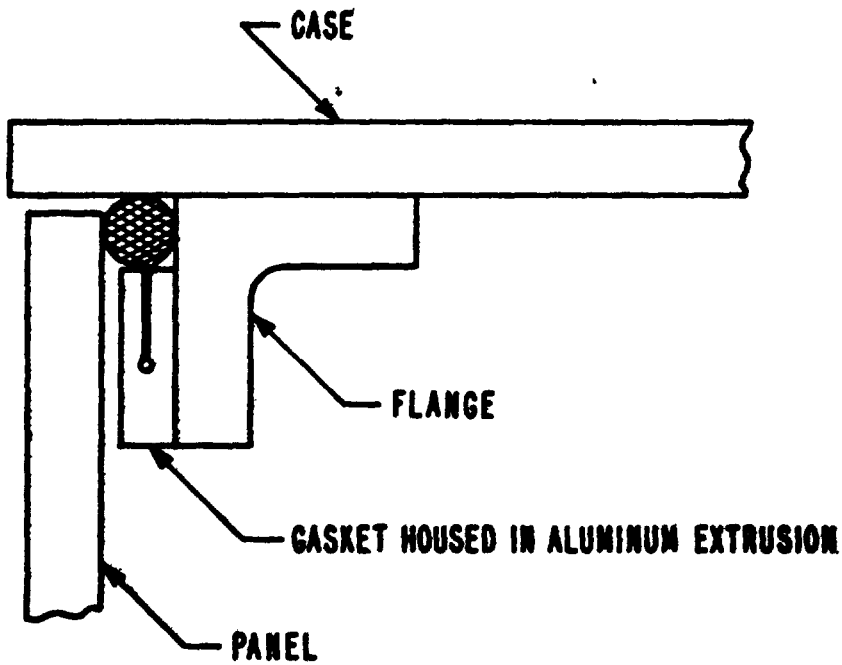

FIGURE 46. TYPICAL CONDUCTIVE GASKETING PROBLEM

3.3.11.5 Conductive Elastomer Materials. Gasket materials of silver conductive elastomer require greater pressure to obtain adequate environmental sealing and EMI shielding effectiveness than other type materials and therefore necessitate strong, well designed and constructed mating surfaces. These materials have low surface and volume resistivity which make them ideal when very low conductivity between mating surfaces is required. However, extreme galvanic action occurs when these materials are coupled with aluminum and magnesium structures requiring special and unique treatment of the mating surfaces. Unless specifically required by the procuring activity silver conductive elastomer materials shall not be used or coupled with magnesium structures. For aluminum mating surfaces baked on irridite treatment per MIL-F-14072 shall be applied prior to a light (.001 to .002 in) coating of silver epoxy paint. Detailed surface treatment and finishes required for use with silver conductive elastomer shall be included in the equipment specification by the procuring activity.

3.3.11.6 Pressure and rain seals. Some applications require seals to be both pressure and interference tight. Figure 47 illustrates a typical sample of this type of seal. A conductive gasket is mounted directly to rubber, or other elastic material, to make a combination pressure and interference seal. This combination seal can be held in place by bonding the rubber to one of the surfaces. Gasketing materials, such as woven metal-neoprene combinations, are less effective than metal finger or mesh gaskets. The metal-neoprene type requires much greater pressure to achieve satisfactory compression, and requires a greater number of fasteners per unit length. Rain tight seals can be made by knitting one or two layers of mesh over a neoprene or silicone material as illustrated by Figure 48. This seal will keep rain out but not water under pressure.

3.3.11.7 Connector seals. AN-type connectors mounted on bulkheads must retain both electromagnetic radiation and fluid seals. In such cases, woven aluminum screens, impregnated with neoprene, should be used. Connectors made to close tolerances should be mounted on a sufficiently rigid surface so that the small amount of compression of this material does the sealing. These gaskets are so small that no other material could be used to make a successful combination sealing gasket.

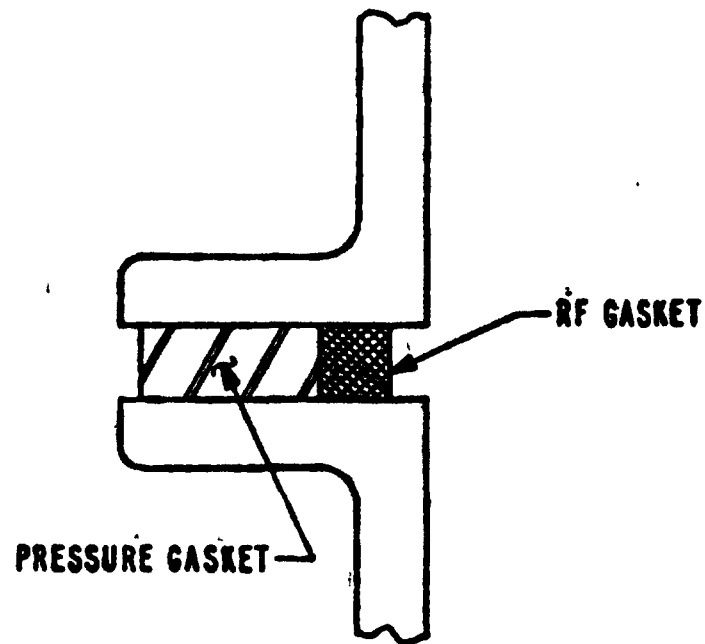

FIGURE 47. PRESSURIZED CONDUCTIVE GASKET APPLICATION

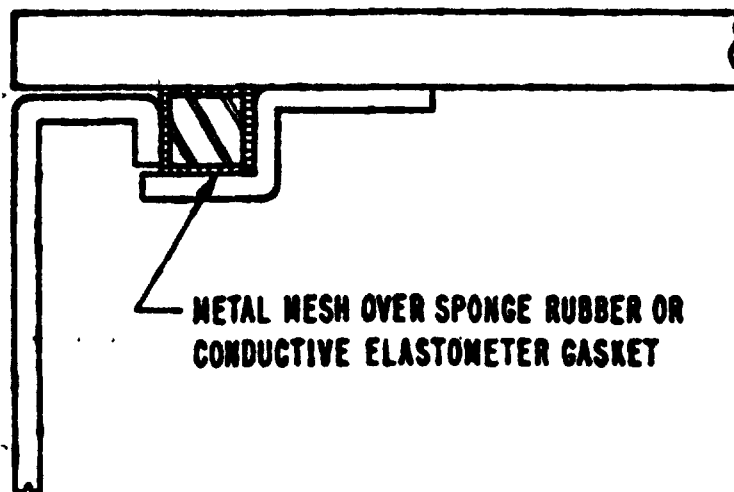

FIGURE 48. RAIN TIGHT CONDUCTIVE GASKET SEAL

3.3.11.8 Characteristics of conductive gasket materials.
Various materials have been used to combine resiliency and conductivity. These characteristics can be combined by using several methods and materials. Some of the more common materials are tabulated in Table VII and described in the following paragraphs. All gasket material shall be in accordance with MIL-P-11268 (Parts, Materials, and Processes Used in Electronic Equipment).

TABLE VII
CHARACTERISTICS OF CONDUCTIVE GASKETING MATERIALS

<u>MATERIAL</u>	<u>Chief Advantages</u>	<u>Chief Limitations</u>
Compressed Knitted Wire	Most resilient all-metal gasket (low flange pressure required). Most points of contact. Available in variety of thickness and resiliencies.	Not available in sheet form. (Certain intricate shapes difficult to make). Must be 0.040 inch or thicker.
Aluminum screen impregnated with neoprene	Combine fluid and conductive seal. Thinnest gasket.	Very low resiliency (high flange pressure required).
Soft metals	Cheapest in small sizes.	Cold flows, low resiliency.
Metal over rubber	Takes advantage of the resiliency of rubber.	Foil cracks if shifts position; generally low insertion loss; poor RF properties.
Conductive rubber	Combines fluid and conduction seal.	Poor RF properties. Practically no insertion loss.
Contact Fingers	Best suited for sliding contact.	Easily damaged, few points of contact.

Convoluted Spiral	Can provide conduc- tion at forces as low as one pound per linear inch. Diameter of one inch can be obtained.	Not available in sheet form. (Many intricate shapes cannot be made). Smallest diameter is 3/64 inch.
----------------------	---	--

3.3.11.8.1 Knitted wire mesh. Knitted wire mesh material is made of many interlocked loop-shaped springs; it combines springiness with flexibility and cohesion. These properties are retained when the mesh is compressed and made dense enough to be an efficient shielding material. These type gaskets shall not be used on magnesium structure.

3.3.11.8.2 Beryllium copper. Beryllium copper gaskets are 10 mil strips of beryllium copper, made by puncturing thin sheets on both sides with a nail. The resultant sharp raised points make contact with both sides of the joint. Such a gasket when imbedded in rubber is a pressure seal as well as RF seal. It can also be used where surfaces are anodized or corroded because it has the ability to cut through the films, making good metal-to-metal contact.

3.3.11.8.3 Imbedded wire. Imbedded wire gaskets have many wires, each shaped like an open V rotated 90 degrees from the plane of the mating surfaces and imbedded in silicone rubber; they make efficient conductive gaskets (Figure 51). The wires in the gaskets have the ability to puncture any oxide film on mating surfaces; and the bends in the wires allow the gaskets to compress while the ends of the wires establish contact. These type gaskets shall not be used on magnesium structures.

3.3.11.8.4 Woven aluminum mesh or screen impregnated with neoprene. Woven aluminum mesh or screen impregnated with neoprene is ground off to expose peaks of the aluminum mesh on both sides. One example of this type of material is 16 gauge aluminum screen impregnated with neoprene.

3.3.11.8.5 Soft metal. Soft metals, such as copper or lead, are used as conductive gaskets.

3.3.11.8.6 Metal over rubber. By covering rubber with metal foil, or wire, the resiliency of rubber is combined with the conductivity of metal.

3.3.11.8.7 Serrated contact fingers. Resiliency is achieved by having cantilever springs. Wiping contact between surfaces may be considered as conductive gaskets.

3.3.11.8.8 Convolute Spiral. Convolute spiral material is wound from thin flat spring material which offers a series of low impedance bond paths which readily conform to the unevenness of a join.

3.3.11.9 Shielding enhancement by conductive gaskets. The permeability of most shielding materials is equivalent to that of air and is one (1). Therefore, the most important characteristic to be maintained is conductance. The principle difficulty of maintaining the same conductance is due to the contact resistance of the basic shielding material and that of the gasket where they join (i.e., the contact resistance between the cabinet and the gasket and between the gasket and cover). The oxide of any of the materials and platings used for shielding exceed 100 ohms, when corrosion due to galvanic action exists at a join, the contact resistance can become significantly greater. The mismatch created by the difference in impedance between that of the join which includes the impedance of the gasket and contact resistance between the different materials will result in a significant decrease in shielding. The shielding of electromagnetic waves usually falls into two categories. These are:

a. Plane wave - i.e., when the wave generating source is a significant distance from the shielding barriers. Typical examples of these are the shielding of electronic equipment from radio, television and radar signals.

b. Magnetic field strengths - i.e., when the wave generating source to be shielded is in an electronic enclosure whose case is providing the shielding, the distance from the source to the shielding barrier is short, and the intrinsic impedance of the wave is low defining the wave as principally a magnetic field.

The ability to reflect the two principal waves is the conductivity of the shielding barrier and gasket, where the lower the conductivity the better the shielding. This is particularly true for the magnetic field wave whose intrinsic impedance is low. If the impedance of the gasket is high or in particular the contact resistance between the gasket and shielding barrier is high, then

the reflective losses can become negligible and the shielding effectiveness will be greatly reduced. This high contact resistance is of particular importance since most of the shielding materials and gaskets used by industry gain a hard relatively non-conducting surface with time. Galvanic action associated with dissimilar metals will also deteriorate the shielding to a very significant degree with time.

3.3.11.10 Qualification of gasket material. Gasket material shall comply with MIL-P-11268 and withstand the equipment environmental requirements of MIL-STD-810. Gasket material shall comply and be tested in accordance with FED. TEST METHOD STD. NO. 406 and FED. TEST METHOD STD. NO. 601, as applicable for the following, as a minimum: These data shall be submitted as part of the EMI/EMC control plan

Parameter	METHOD	
	STD 406	STD 601
Brittleness	2051	5311, 5321
Compression	1021	12151, 3321, 3331, 12141, 3311, 12131, 5411
Durometer	1082, 1083	3025, 3021, 5511
Elongation	1011, 1012 1013, 1063	4121, 10311, 11021, 13031
Tear Strength	1121	4211, 4221
Tensile Strength	1011, 1012 1013, 1063	4111, 11011, 13021, 6111, 6121, 4131
Volume Resistivity	4042	9111

3.3.12 Insertion loss. Figure 49 depicts insertion loss, in decibels, of a resilient metal gasket, plotted against applied pressure. This insertion loss is the resuction of RF energy leakage that results when a conductive gasket is inserted in a previously ungasketed joint. In (Figure 50) using the attenuator, E_2 is made the same in both cases, and F_1 is kept constant, the calibrated attenuator measurement then yields the insertion loss directly. When tests were run for various frequencies, gasket materials, and joint materials, the specific values of insertion loss changed, but the shape of the curve remained the same. There was always a point at the knee of the curve where additional pressure did not change the insertion loss. On the average, this point occurred at 20 pounds per square inch. Figure 51 shows an imbedded wire type gasket. Figure 52 shows serrated contact fingers. Insertion loss measurements shall be performed in accordance with SAE ARP 1173. Insertion loss data for each type gasket used shall be submitted as part of the EMI/EMC control plan.

3.3.13 Classification of joints.

3.3.13.1 General. Joints vary not only in their degree of misfit, but also in manner and number of openings and closings during the life cycle of the equipment. Resilient metallic gaskets will take some set when compressed. Joints are classified as follows:

a. Class A, premanently closed. After initial closure, a Class A, permanently closed joint is opened only for major maintenance or repair. Feedthrough mounted interference filters and waveguide joints are Class A joints.

b. Class B, fixed position. In a Class B. joint, the relative positions of mating surfaces and gasket are always the same. For instance, any point on the edge of a door will close against its equivalent point on the jamb after every opening. In a Class B joint, the gasket is compressed and released from the same operating height at the same point on the gasket many times during its life. Hinged lids and doors, and rack and panel installations, are typical of Class B joints.

c. Class C, completely interchangeable. A Class C joint is one in which mating surfaces and shielding materials are

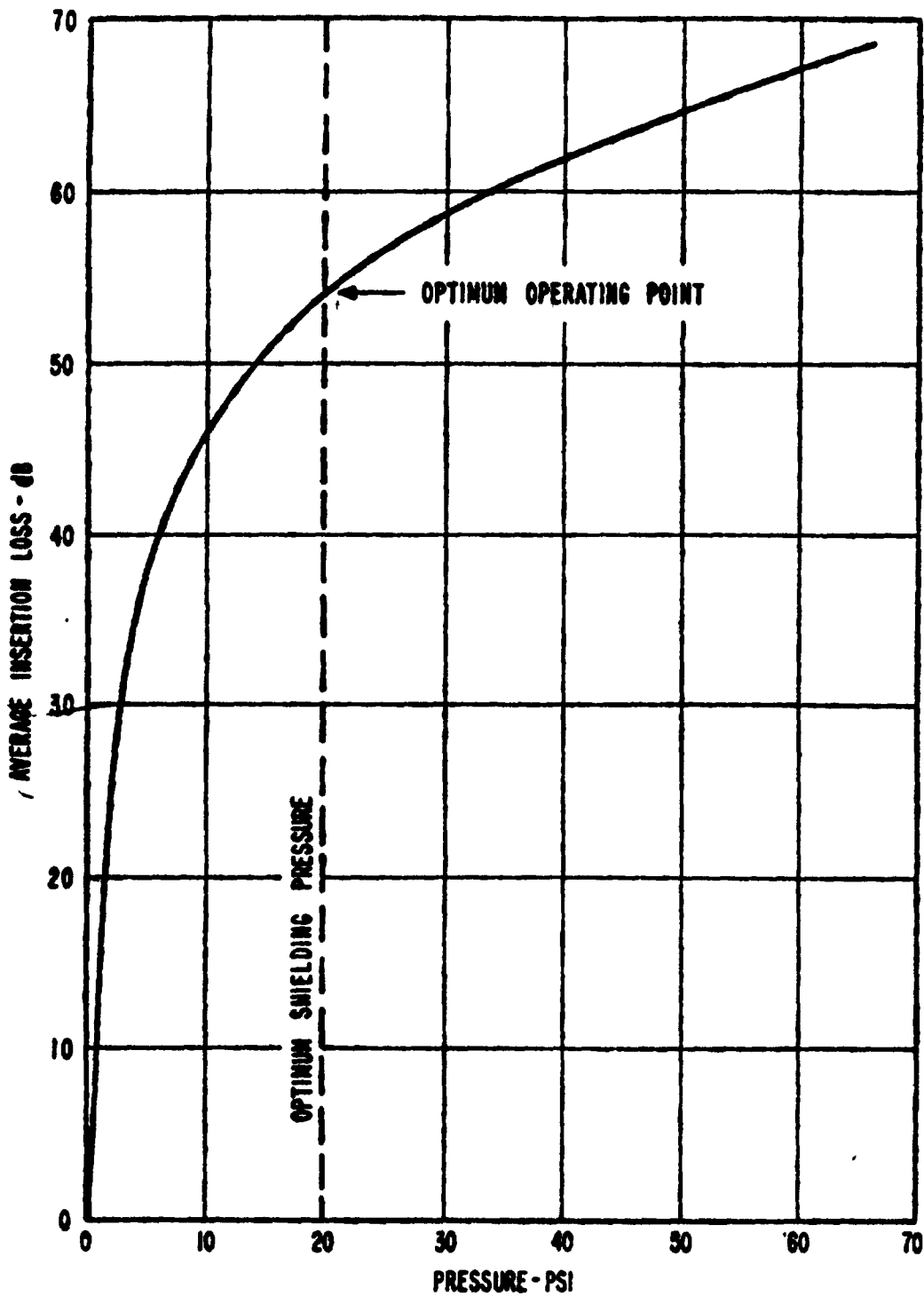
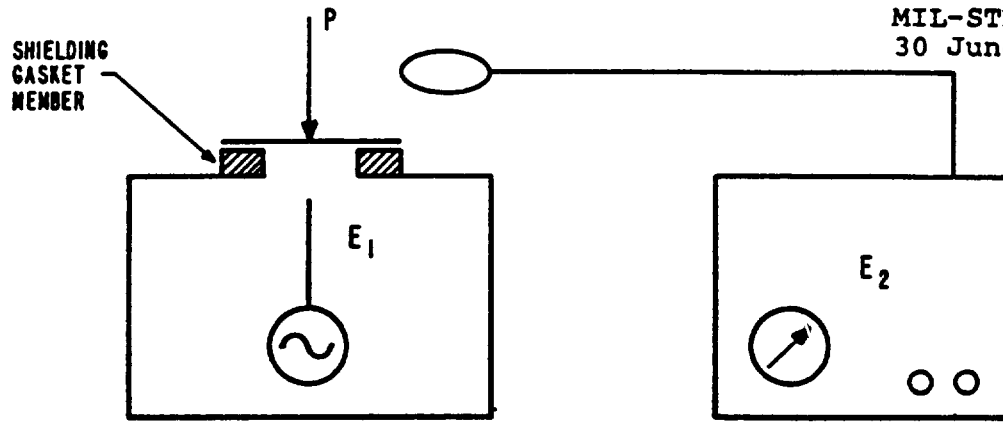
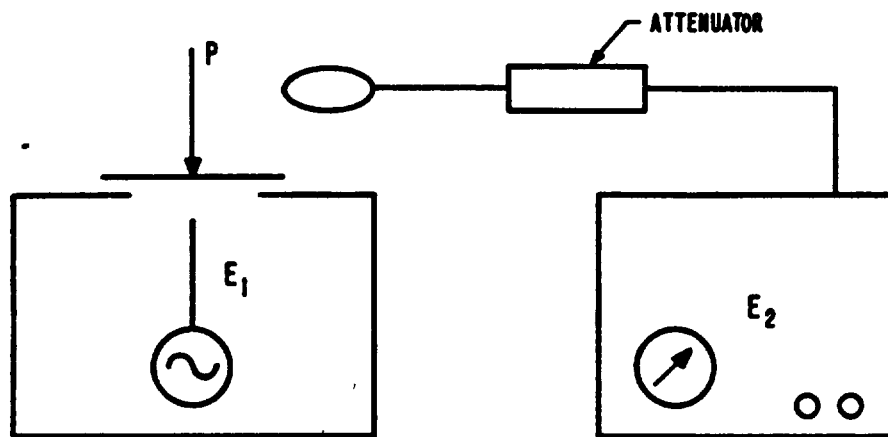

FIGURE 49. INSERTION LOSS VS PRESSURE FOR RESILIENT METAL GASKET



A. E_2 OBTAINED FOR VARYING VALUES OF P WITH GASKET SHIELDING MATERIAL. E_1 HELD CONSTANT.



B. E_2 REPEATED FOR VARYING VALUES OF P WITH NO SHIELDING GASKET MATERIAL PRESENT. INSERTION LOSS MEASURED BY ATTENUATOR. E_1 HELD CONSTANT.

FIGURE 50. TECHNIQUE FOR MEASUREMENT OF INSERTION LOSS OF RESILIENT METAL GASKET

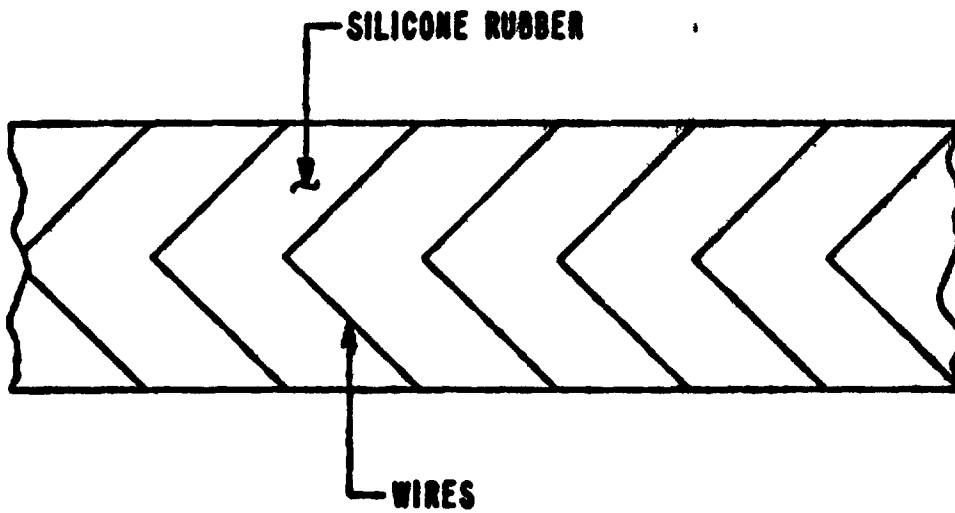

FIGURE 51. INTERFERENCE GASKET OF THE ARMOUR RESEARCH TYPE

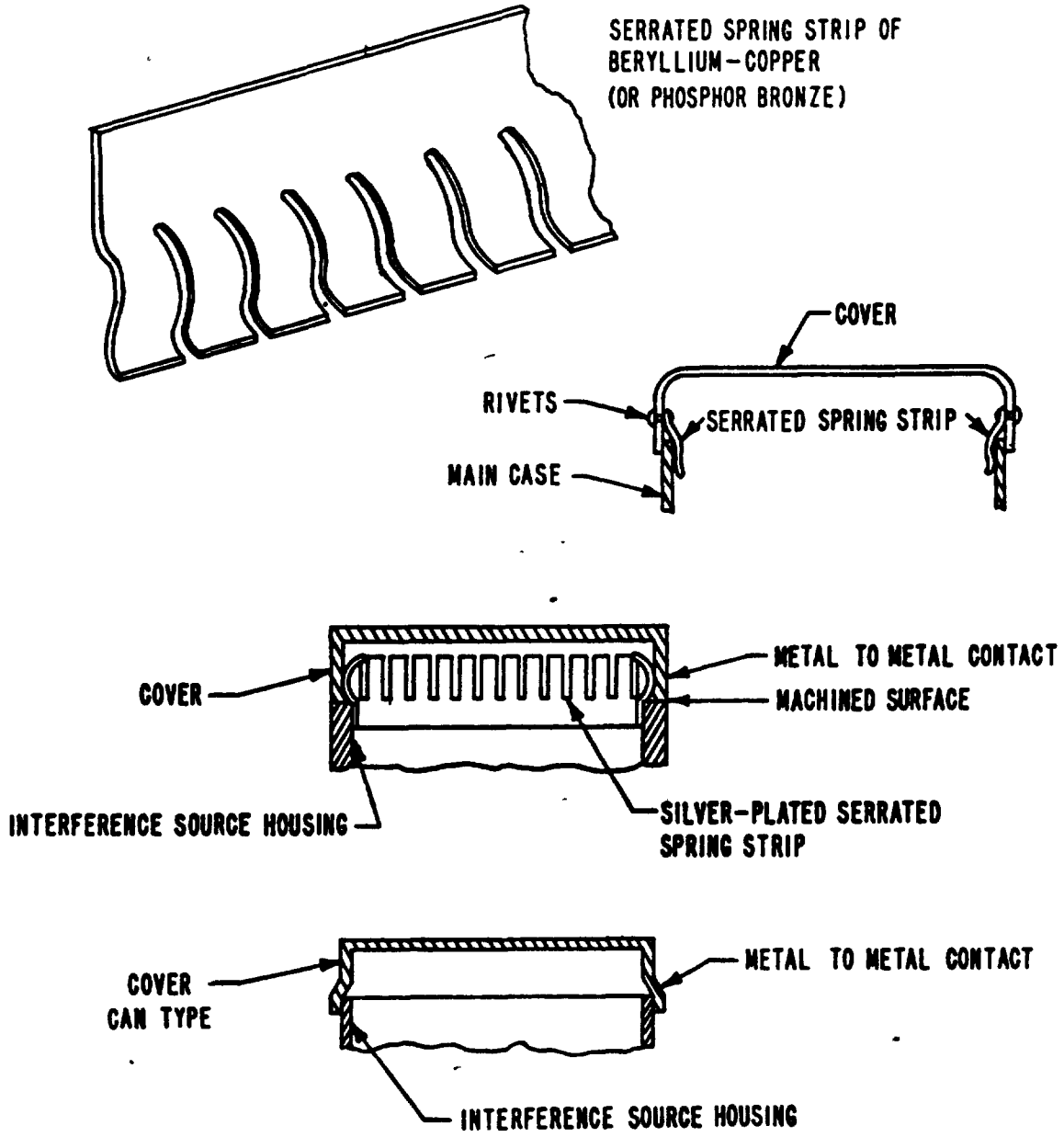

FIGURE-52. METAL-TO-METAL CONTACT TECHNIQUES OF COVER AND CASE FOR INTERFERENCE SHIELDS

completely interchangeable, and/or the relative positions of two mating surfaces and gasket may change. In a Class C joint, the gaskets may be compressed to several different operating points many times. Symmetrical cover plates and waveguide choke flanges are examples of Class C joints.

3.3.13.2 Conductive gasket selection. The design goal for conductive gasket application is a gasket, resilient enough to make continuous contact on irregular surfaces, and provide a low impedance across the joint. Various forms of conductive gaskets are available in monel, tin plated beryllium copper, stainless steel, tin, plated iron, silver-plated brass, and aluminum. These materials are shown in Table VIII. When conductive gaskets are used in contact with an aluminum or magnesium structure, special surface treatment of the metal is required.

3.3.14 Special shielding techniques.

3.3.14.1 Gas discharge lamps. Gas discharge lamps such as fluorescent lights, ultraviolet, and neon lamps are sources of interference; interference control for them is a matter of isolation and containment. This interference arises from the electromagnetic energy that is liberated when gas is ionized. The ionic discharge generates EM interference, usually in the low megahertz range, which appears at the terminals of the lamp and is radiated from the glass bulb and interconnecting leads. Fluorescent lamps contain mercury vapor at low pressure which is ionized by the flow of electrons in the tube. The subsequent deionization causes ultraviolet radiation. This excites the phosphor coating on the inside of the tube, causing it to emit light in the visible region, since this process employs ionized elements whose changed energy level gives rise to radio interference. There are three ways in which these lamps can transmit radiated interference to receivers: By radiation directly from the lamp, radiation from power leads, or both. Lamps of this type cannot be shielded with sheet metal without eliminating all of the useful light output. Screen wire should be used. Coated glass which transmits over 90 percent of the visible light while providing adequate interference shielding should be considered. The function of the coating on the glass is to intercept and ground out radiated interference. Typical construction consists of a heat-resistant, borosilicate glass panel having a permanently bonded, transparent, electrically-conducting film applied to its smooth side. A 0.25 inch wide metal grounding strip is fired onto the film around the periphery of the glass panel. A conductive silver paint is applied to make good contact between the glass panel and the frame; and the frame is bonded to the metal fixture ground plane. The glass coatings exhibit resistances ranging from 50 to 200 ohms per square inch and thus reduce radiated interference in the frequency range from 0.014 to 25 MHz.

TABLE VIII GUIDE TO CHOICE OF TYPE OF RF GASKET BASED ON MECHANICAL SUITABILITY

MIL-STD-1857(EL)
30 June 1976

		1, WELL SUITED, 2, CAN BE CONSIDERED, 3, NOT SUITED														
		MESH STRIPS				EXTRUSION GASKET	COMBINATION STRIP	FOURED RF GASKETS	MESH GASKETS OR EQUIVALENT	COMBINATION GASKETS	WOVEN ALUMINUM + NEOPRENE	MESH OVER RUBBER	CONDUCTIVE RUBBER ¹	FIBERS	CONVULATED SPIRAL	
		○	□	⊂	⊃											
ATTACHMENT METHOD	HELD IN A SLOT OR GROOVE BY TIGHT SIDEWALL FIT	1	1	3	3	3	2	1	3	2	3	1	1	3	3	3
	NONCONDUCTIVE SPOT-BONDING ^a	2	1	2	2	3	2	1	3	2	2	1	1	3	2	1
	NONCONDUCTIVE BONDING AROUND FROM RF GASKET PORTION ^b	3	3	1	1	3	1	3	3	1	3	3	3	3	3	1
	BOND RF GASKET PORTION WITH CONDUCTIVE ADHESIVE ^c	2	1	2	2	3	2	1	3	2	2	1	1	3	2	1
	SCREW, SPOTWELD OR RIVET	3	3	1 ^d	1 ^d	1	3	3	2	3	3	3	3	1	3	1
	SOLDER	3	2	2	2	3	3	2	2	3	3	3	3	1	3	3
	POSITION BY BOLTS THROUGH BOLT HOLES	3	3	2	2	1	1	2	1	1	1	3	1	3	3	1
	PRESSURE-SENSITIVE ADHESIVE BACKING	3	3	3	3	3	1	3	3	1	3	3	3	3	3	1
OTHER GASKETING FUNCTIONS	COOLING AIR TIGHTNESS	3	3	3	3	1	1	3	3	1	1	1	1	3	3	1
	RAIN TIGHTNESS	3	3	3	3	1 ^e	1	3	3	1	1	1 ^e	1	3	3	1
	PRESSURE TIGHT	3	3	3	3	3	1	3	3	1	1	3	1	3	3	1
PRESSURE AVAILABLE	0 - 5 PSI ^f	1	1	1	1	1	1	1	2	1	3	1	1	1	1	1
	5 - 50 PSI	1/2	1	1/2	1/2	1	1	1	1	1	1	1/2	1	2	1	1/2
	OVER 50 PSI	2	2	2	2	1	2	2	1	2	1	2	1	3	1	2
TOTAL JOINT UNEVENNESS ^g	LESS THAN 0.002	1	1	1	1	1	1	1	1	1	1	1	1	1	1	1
	0.002 TO 0.030	1	1	1	1	1	1	1	1	1	3	1	2	1	1	1
	0.030 TO 0.060	1	1	1	1	1	1	1	1	2/3	1	3	1	2/3	1	1
	OVER 0.060	1	1/2	1	1	2	2	1/2	3	2	3	1	3	1	1	1
SPACE AVAILABLE, WIDTH	LESS THAN 0.060 ^h	1	1	3	3	3	3	2	3	3	1	3	1	3	1	1
	0.060 TO 0.500	1	1	1	2	2/3	2	1	2	2	1	1	1	2	1	1
	0.500 TO 1.50	1	1	1	1	1	1	1	1	1	1	1	1	1	1	1
SPACE AVAILABLE, THICKNESS	LESS THAN 0.030	3	3	3	3	3	3	3	2	3	1	3	2	2	3	3
	0.030 TO 0.060	1	1	2	2	3	2	1	1	2	3	2	1	1	1	3
	0.060 TO 0.090	1	1	1	1	2	2	1	1	2	3	2	1	1	1	1
	OVER 0.090	1	1	1	1	1	1	1	3	1	3	1	1	1	1	1
TYPE OF JOINT	COMPRESSION ONLY	1	1	1	1	1	1	1	1	1	1	1	1	1	1	1
	COMBINED COMPRESSION & SLIDING	2	2	2	2	2	2	2	3	2	3	2	2	1	2	2
	SLIDING ONLY	2	2	2	2	2	3	2	3	3	3	2	3	1	2	2

- a - NONCONDUCTIVE SPOT BONDING: A NONCONDUCTIVE ADHESIVE CAN BE USED DIRECTLY UNDER AN RF GASKET IF IT IS USED ONLY IN 1/8- TO 1/4-INCH DIAMETER SPOTS, 1- TO 2-INCHES APART.
- b - A NONCONDUCTIVE ADHESIVE CAN ALWAYS BE USED CONTINUOUSLY IF IT IS USED UNDER THE ATTACHMENT OR RUBBER PORTION OF COMBINATION STRIP AND GASKETS, BUT NOT UNDER THE RF GASKET ITSELF
- c - A CONDUCTIVE ADHESIVE CAN BE APPLIED CONTINUOUSLY UNDER AN RF GASKET
- d - WITH BACKING STRIP OVER ATTACHMENT PINS.
- e - IF MESH-OVER-RUBBER VERSION OF EXTRUSION GASKET IS USED.
- f - EVALUATION IS ONLY FOR MECHANICAL SUITABILITY. PRESSURE MAY BE HIGH ENOUGH TO GIVE SUFFICIENT INSERTION LOSS
- g - EVALUATION BASED ON SPACE BEING AVAILABLE TO USE THICK ENOUGH GASKET
- h - INCLUDING SPACE FOR ATTACHMENT METHOD INTEGRAL TO MATERIAL CONSIDERED
- i - EVALUATION IS NOT BASED ON ELECTRICAL SUITABILITY OF CONDUCTIVE RUBBER WHICH IS GENERALLY POORER THAN OTHER MATERIALS LISTED

3.3.14.2 Magnetic shielding techniques. Well engineered circuits can be affected by interference from spurious magnetic fields set up by neighboring components. These effects can be minimized by judicious orientation of components on the chassis. The solution of most of these problems may be achieved in the use of a magnetic shield around the affected component. A magnetic shield is a low-reluctance path in which the magnetic field is contained. Effective shields should be made of high permeability nickel-iron alloy such as Mu-metal. There are many applications where a single shield will not reduce the field to a low enough value. In such cases, a nest of shields is required. Additional shields should be installed to achieve the degree of suppression required. These should be isolated from each other to ensure maximum permeability of the group. This is accomplished by using 0.010 inch thick Kraft paper as a separator. Structurally, magnetic shields are made in two categories: those produced by deep drawing from flat blanks and those formed and welded. Because of difficulties involved in deep drawing nickel-iron alloys, since nickel-iron alloys harden very rapidly in the drawing process, generous radii must be provided to prevent tearing. In drawing Mu-metal cans, care should be taken to relieve the internal strains as quickly as possible. Shields for such items as transformers, cathode-ray tubes and photomultiplier tubes are fabricated from flat, unannealed sheets of metal. The material is bent on brakes or rolls, and the joints are overlapped and spot welded. All holes and slots are pierced prior to the forming operation. After fabrication, shields are given a final heat treatment in pure, dry hydrogen at 2050°F to develop the required permeability. Before this final treatment, the permeability is approximately five percent of the ultimate that is developed by the annealing process. It has been found that a 3/8 inch overlap of material must be provided to prevent any transmission of the interfering field. Spot welding at intervals of 1/2 inch shall be used to seal joints. Placement of joints in the shield surface affects the shield effectiveness. In a cathode-ray tube shield, for example, joints in the axial direction of the tube have little degrading effect on shielding effectiveness, but joints normal to the axis reduce the effectiveness of the shielding. Figure 53 shows examples of these constructions, and also the developed blanks from which they are formed. The blank used to form the shield with the axial joint (Figure 53A), has a maximum flux path; the normal joint in the second example (Figure 53B) divides the blank into two parts that have lower permeance, resulting in decreased shielding effectiveness. If space and mounting are no problem, cost can be cut by eliminating expensive layouts, as shown on Figure 54. Here, a simple frustum of a CRT cone that

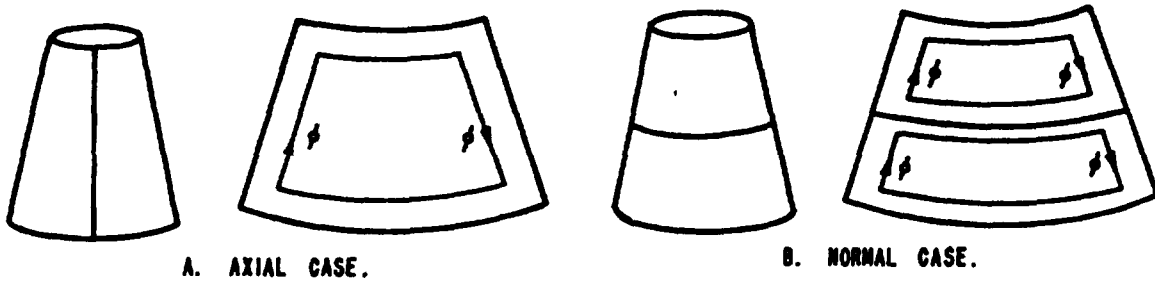

FIGURE 53. EFFECT OF JOINT ORIENTATION ON FLUX PATHS

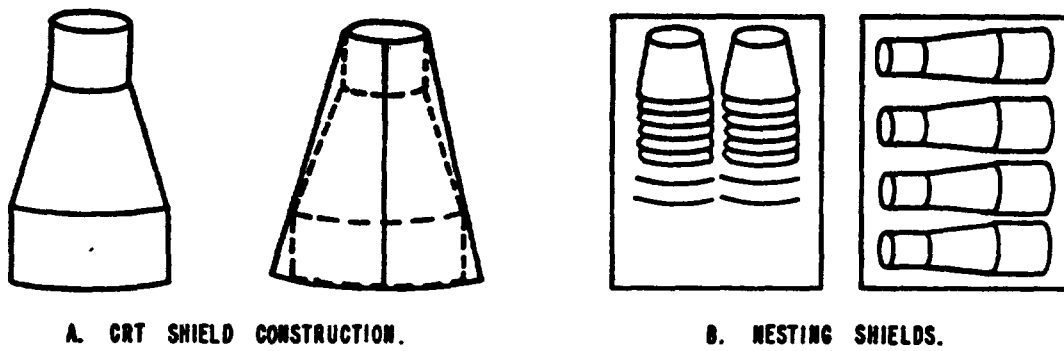

FIGURE 54. SHIELD ECONOMICS

follows the contour of the tube is substituted for a three piece construction (Figure 54A). In addition to the economy realized through simpler construction, annealing costs are reduced by nesting the cones in the annealing box, as shown on Figure 54B. Schedule annealing operations of annealed Mu-metal sheets to eliminate the much higher cost of annealing in the final form, since the permeability of Mu-metal is adversely affected by cold work. For magnetic shielding high permeability materials have the same basic constituents of 80 percent nickel, 20 percent iron. The shielding effectiveness varies with RF field frequency. The lower the frequency, the lower the shielding effectiveness. Since 80 percent nickel alloy is difficult to draw and form use the polyform process: casting a matrix in a die or mold to the desired shape. The matrix should be rotated and cooled while the magnetic shielding material is sprayed on it to the desired thickness. When complete, subsequent grinding drilling and machining is accomplished for optimum shielding efficiency and ductility; annealing should follow this stage. Where necessary, shielding effectiveness may be further improved by laminating. A sprayed layer of copper inserted between layers of shielding material provides special characteristics. This can be done with ease, at little additional cost. The solution to the problem of shielding against magnetic fields internally generated by transformers and coils shall be done by shielding the source and/or shielding the component or chassis most affected. Multiple shields are sometimes required to extend the magnetic and electric shielding into higher frequency ranges. Laminates of magnetic and high-conductivity materials are used; the former for shielding of a magnetic field, and the latter for shielding of electric field.

3.3.14.3 Data output openings. Data output openings, such as those for direct view storage tubes, cathode-ray tubes, and meters, represent a shield discontinuity in an equipment case. Meters and other visual readout devices present interference protection problems. Materials that are optically transparent are ineffectual shields. This problem is overcome by installing a shield around the rear of the readout device and filtering all leads entering and leaving it, as shown on Figure 55. A number of semi-transparent shielding materials are available for application to data output and display devices. Included are copper mesh screening, perforated metal, conductively coated glass, and conductively coated plastic. The optical and electrical transmission properties of some of these materials are summarized in Table IX. A comparison of relative levels at three frequencies indicates that, for virtually all of the conductively coated materials, the ratio of electrical transmittance to optical transmittance is relatively high. For instance, a 30 micron thick gold film on plastic yields an electrical transmittance of 0.16 percent (at 5.9 GHz) and an optical transmittance of 24 percent. In an electromagnetic field the material's electrical transmittance decreases with frequency; at higher frequencies, considerably lower electrical transmittance (better shielding qualities) are obtained.

3.3.14.4 Direct view storage tubes. The application of magnetic shielding to direct view storage tubes eliminates the effects of stray magnetic fields. A double shield is required to stop these fields; it should consist of one shield of Netic type alloy and one shield of Co-Netic type alloy. Principal Netic type alloy material characteristics are high-flux capacities and extremely low retentivity. Co-Netic type alloy materials are more effective for low intensity, low frequency problems. The inner shield should be of Co-Netic type material or an equivalent; the outer shield, Netic type material or an equivalent. The Co-Netic type shield should be 0.025 inch thick; the Netic type shield, 0.062 inch thick. In this arrangement, a stray static magnetic field is reduced by a factor of 1000, and an ac magnetic field at 60 hertz is reduced by a factor of 30,000.

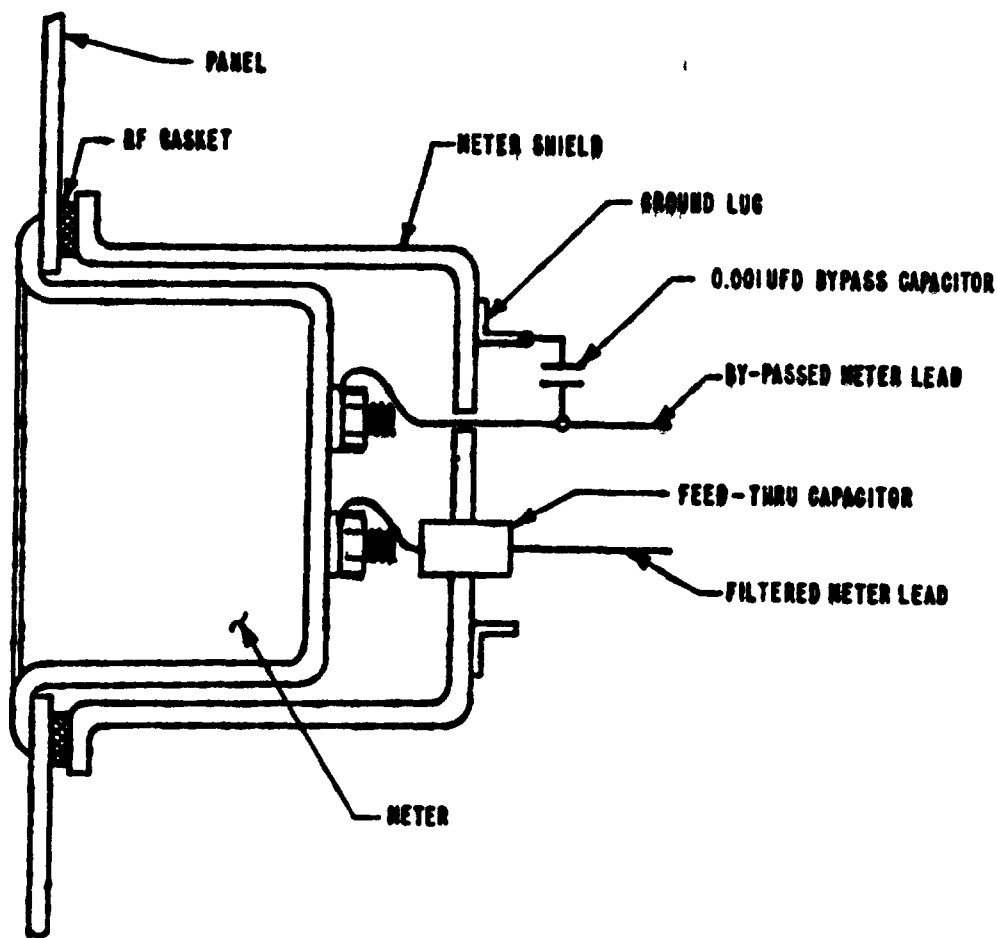

FIGURE 55. METER SHIELDING AND ISOLATION

TABLE IX MICROWAVE AND OPTICAL PROPERTIES OF SEMITRANSSPARENT SHIELDING MATERIALS

Material	Microwave Transmittance (Percent)			Optical Transmittance (Percent)
	5.9 GHz	9.7 GHz	18.8 GHz	
Gold film about 11 μ thick on plastic (300 ohms/square)	23	10	0.8	49
Gold film about 30 μ thick on plastic (12 ohms/square)	0.16	0.1	0.01	24
Gold film about 75 μ thick on glass (1.5 ohms/square)	0.04	0.01	0.004	3.2
Copper mesh (20 per inch)	0.1	0.2	0.2	50
Copper mesh (8 per inch)	1.0	1.3	2.5	60
Lead glass (X-ray protective, 1/4 inch thick)	30	25	16	85
Lucite (3/16 inch thick)	80	50	25	92
Libby-Owens-Ford Elettropane glass, with conductive coating about 150 μ thick (120 ohms/square)	16	16	16	85
Libby-Owens-Ford Elettropane glass, with conductive coating about 300 μ thick (70 ohms/square)	9	10	8	80
Corning heating panel glass, with conductive coating about 1.5 μ thick (15 ohms/square)	1.6	1.2	0.08	45

3.3.14.5 Cathode-ray tubes. Cathode-ray tube apertures represent major shield discontinuities. Shielding for the condition is difficult because of the requirement for unrestricted transparency (Figure 56). For correct shielding construction, it is necessary for all items that penetrate the shielding, such as pipes and conduits, to be electrically bonded to the shielding at the point of entrance by brazing or welding. Handles, latches, screw heads, nails, and other metal projections that pierce the shield should be brazed or welded to the shield; all discontinuities should be bonded in continuous seams. A metal element that projects through the shielding can act as an antenna picking up electromagnetic energy and reradiating it. At high frequencies, such isolated hardware is comparable to, and can radiate as, a waveguide probe. Bonding between such a projection and the shielding will eliminate the antenna effect.

3.3.14.6 Indicating and elapsed time meters. Meter movements should be shielded against ac and dc magnetic fields. The most common sources of interference to unshielded meters are transformers, motors, generators, current-carrying cables or buses, solenoids, and other components producing magnetic fields. Shielding against interference from such items permits use of meters in these environments.

3.3.14.7 Fuse holder and indicator lamp openings. In electronic equipment, both active and spare fuses apertures are sources of interference since they can act as antennas. The lack of shielding in fuseholders permits high-frequency interference to propagate through the opening in an otherwise well shielded panel. For proper shielding, group all fuseholders together; a shield of solid metal with wire mesh gasketing should then be used to surround the fuse cluster. Shielding approach to be utilized for indicating lamps shall provide screening and/or special conducting glass.

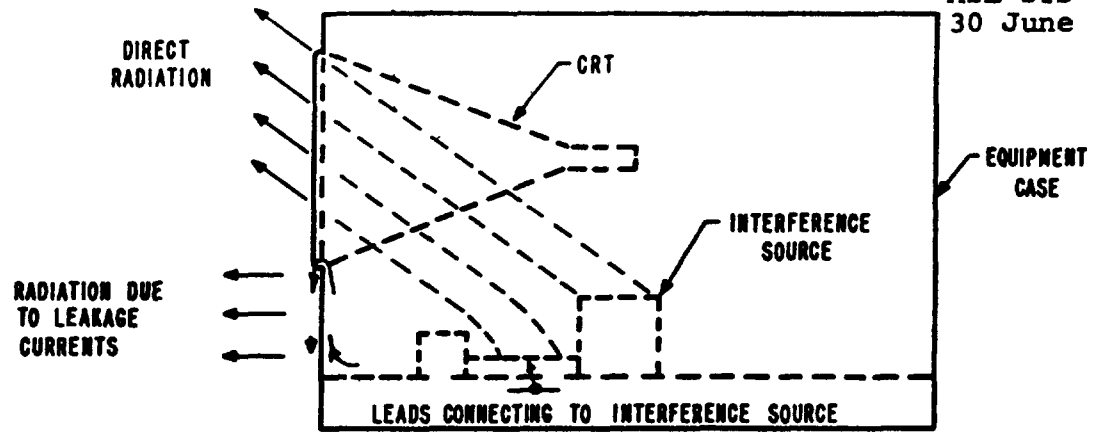

A. TYPICAL CATHODE RAY TUBE INSTALLATION.

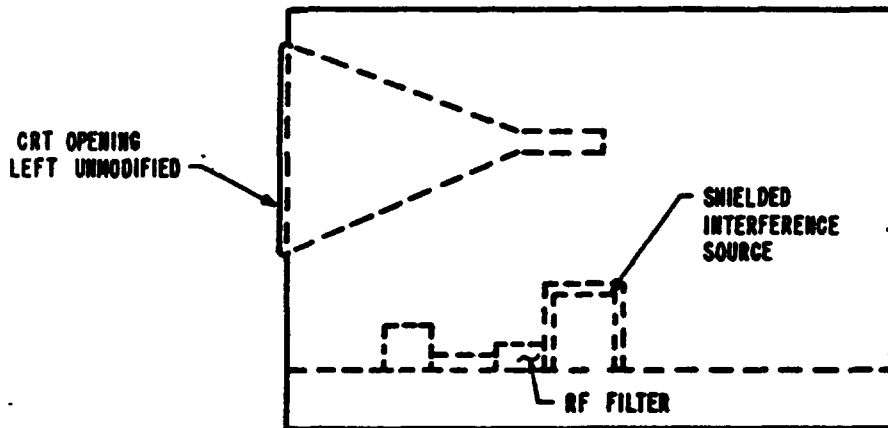

B. SUPPRESSION BY INTERNAL SHIELDING AND FILTERING.

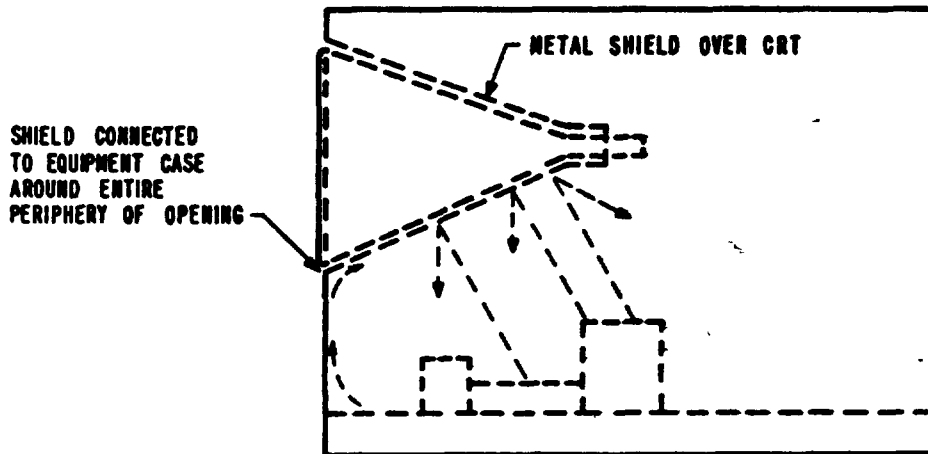

C. SUPPRESSION WITH CRT SHIELD

FIGURE 56. TREATMENT OF CATHODE RAY TUBE OPENINGS

3.3.14.8 Switching devices. Components, such as solenoids or other devices involving high inrush currents or incorporating switching devices that normally develop high amplitude transients, will be a problem in interference-free design. Such units should be completely enclosed in a shield. Since Mu-metal cannot be drawn into tubing because it loses shielding effectiveness when cold worked, an adequate shield should be developed by wrapping a continuous layer of annealed Mu-metal tape around the wire cable. Annealed Mu-metal tape, 0.001 inch thick and 0.25 inch wide, wrapped in two layers could provide a suitable solution to this problem. The first layer can be spaced approximately 0.125 inch between convolutions, with the second layer overlapping the first layer to cover the gaps between turns. The assembly can be covered with a protective rubber coating and may be flexed without losing its shielding effect. A form of shielded cable using four counterspiral wound bands of foil, Netic, Co-Netic, or their equivalent, is also recommended. This construction is shown on Figure 57. The strips can be from 0.25 inch to 1 inch wide. To avoid leakage, it is necessary to wind the material so as to permit spiral positioning along the length of the cable, with each following layer consisting of another spiral in the opposite direction. Layers of the tape wound in this manner will ensure a minimum of gaps and permit cable flexibility. Spiral wound shielded cables are commercially available. A design engineer who encounters the need for a shield of this nature can procure the tape in foil form and, for evaluation purposes, fabricate a prototype shield for his own cables. For conductors carrying currents greater than two amperes, the first two layers should be Netic S3-6 foil or its equivalent; the remaining layers should be Co-Netic AA foil or its equivalent. Netic and Co-Netic type foils, or their equivalents, are available from 0.002 to 0.007 inch in thickness and in various widths. Also, these alloys provide a simple method of shielding transformers and small reactors; the foils must be carefully wrapped around, with the necessary number of layers to provide the desired attenuation. After wrapping, the cable can be potted or encapsulated to prevent unraveling of the foil. The Netic-type foil and its equivalents carry relatively high flux densities; the Co-Netic-type foil and its equivalents offer maximum attenuation. When an interfering field is of sufficient intensity to saturate the Co-Netic type foil, Netic-type foil should be placed between layers of Co-Netic foil. The Netic-type foil, under circumstances, acts as a buffer for the Co-Netic type foil.

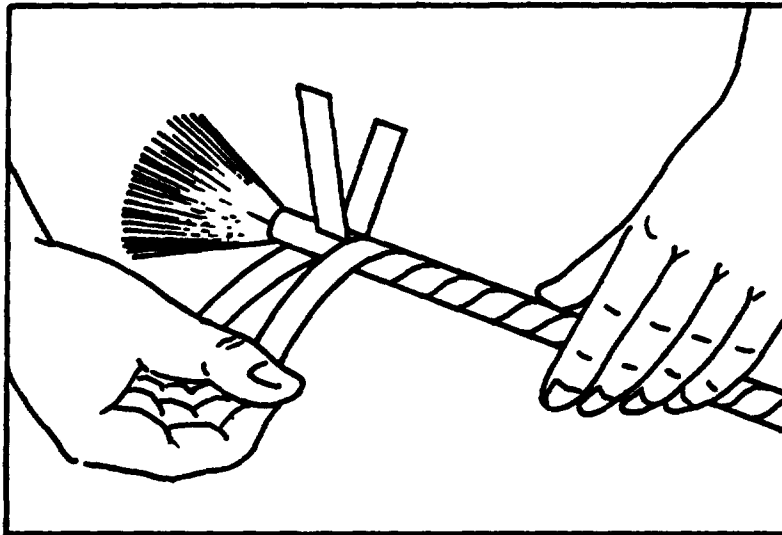

SHIELDING CABLE WITH FOUR BANDS
OF FOIL

FIGURE 57. MAGNETIC AND ELECTROSTATIC CABLE SHIELDING

3.3.14.9 Conductive surface coatings. For highly conductive surface coatings specifically formulated for shielding applications use conductive epoxies. They are fine, silver-based lacquers that adhere excellently to metal, plastic, ceramic, wood, and concrete. When applied to a nonconductor, the surface resistivity is substantially less than 1 ohm/square inch. Successive coats further decrease the surface resistivity. These coatings are often used to improve the RF integrity of metal housings or screen rooms. This is done by applying a surface coating to joints, seams, and contacting surfaces. The material is sufficiently fluid so that it readily flows into cracks. Metal-to-metal contact is improved significantly by applying such coatings. The surface coating fills slight irregularities and makes intimate contact with exposed metal. Thereby corroded joints can be made into greatly improved interference seals. Spraying of the coating can drive the silver particles into crevices and other hard-to-reach places. In a typical shielded box or enclosure of complete metal construction, application of conductive epoxy, or its equivalent, to all contact surfaces improves insertion loss by a value of about 30 dB over the frequency range from 15 kHz to 10 GHz. Thin coating material will not fill gross voids at joints or seams; a caulking conductive compound must first be used in such applications. When these coatings are to be used on a metal surface, grease, oil, wax, paint, dirt and other non-conductive films must first be removed with a solvent or cleansing agent, or by grinding, buffing or machining the surface to be coated. When electrical contact is established with the metallic base, the coating shall be applied to the prepared surface by brush or spray. The coating should air dry to less than one ohm per-square-inch surface resistivity in one hour. Additional coats can be applied as desired. Some of the conductive surface coating and caulking applications are illustrated on Figure 58 and summarized in Table X. The conductive caulking compounds have the consistency of putty and can be applied by hand or with an air-activated gun. The thickness of deposition is easily controlled. Some of the compositions do not harden or set and therefore do not permit joint break but do allow flexibility; others cure to a hard resin surface and, still others, to a rubbery consistency. Elevated temperature cures can be used and are recommended. The joints should be maintained under pressure. Excess compound, squeezed from the joint, can be recovered and reused. Conductive caulking compounds should not be relied upon to hold a joint together. There are conductive epoxies with great holding power.

CAULKING COMPOUND LAID
UNDER CHANNELS BEFORE
DRAWDOWN TO PREVENT
HAIRLINE CRACKS

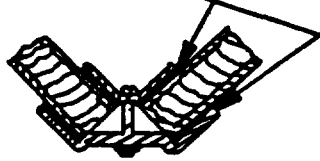

A. VERTICAL OR HORIZONTAL
CORNER OF SHIELDED ROOM.

HARD SETTING EPOXY
TYPE CAULKING COMPOUND

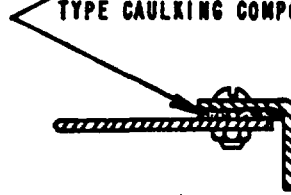

B. CORNER OF EQUIPMENT CABINET.

CAULKING COMPOUND



C. SHW AND R.F. TIGHT
EXPANSION JOINT.

CAULKING COMPOUND

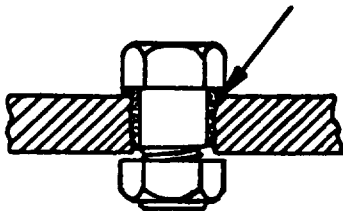

D. FASTENER
(WASHERS CAN ALSO BE USED)

CAULKING COMPOUND

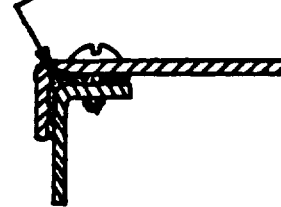

E. TOP COVER OF
EQUIPMENT CABINET.

FIGURE 58. TYPICAL CONDUCTIVE CAULKING APPLICATIONS

TABLE X. CONDUCTIVE SURFACE APPLICATIONS

<u>Application</u>	<u>Previous Method</u>	<u>Present Method</u>	<u>Advantages</u>
Seams and static joints in rooms, containers, and enclosures	Welding or soldering	Caulking compounds	Ease of application; reliable performance; no damage to metal surfaces, flex resistance; no hairline cracks
	Knurled surfaces on clamped joints; metal strips for overlapping seams	Caulking compounds	Bolt spacing increased; no hairline cracks; lighter weight joints; accommodates expansion, contraction, warping, and vibration
Sealing of doors, access hatches, container covers, and flanges	Woven wire mesh strip; copper finger stock	Gaskets Strip gaskets	RF and pressure seal with a single material; low-sealing pressures; small-gap spacings; good compression set; high attenuation
	Oriented wire mesh embedded in rubber strip	Strip gaskets	Reusable; reliable performance; high attenuation
	Machined metal seal with mated O-ring, knurled contact surface; wire screen filled with rubber	Seal gaskets	No scarring of flange faces; lower cost; reusable; low-sealing pressures
Sealing of fasteners, bolts, nails, screw heads	Welding or soldering	Seal caulking compounds Seal gaskets	Ease of application; reliable performance; no damage to metal surfaces; easily disassembled.

MIL-STD-1857(EL)
30 June 1976

3.3.15 Cabling.

3.3.15.1 General. Interference may be transferred from one circuit or location to another by interconnecting cabling. The interference may be radiated from a cable or transferred into a cable from external fields. Once interference has been transferred by radiation or common-impedance circuit elements into a cable circuit of an electronic or electrical complex, it can be conducted through interconnecting cables to other elements of the complex. Also, because of cable proximity in cable runs or elsewhere, intra- and/or intercable crosstalk may occur as a result of electromagnetic transference between cables. The term cabling here encompasses proper selection, assembly, and routing of cables, connectors, and interconnecting circuitry. The cables may be of the commercially available type, prefabricated or specially assembled from a group of individually insulated conductors.

3.3.15.2 Cable shielding. Electrical cables may be unshielded, individually shielded, shielded as pairs or groups, or shielded as a whole by a single shield. When a shield is used, it generally consists of a braid or conduit. The purpose of such shielding is to attenuate radiated interference and susceptibility. Proper care should be taken during installation to ensure that shielding integrity is maintained. The choice of cable to be utilized depends upon the characteristic impedance desired, amount of signal attenuation permitted, environment within which the cable must exist, and characteristics of the signal to be transmitted. Signal isolation between different cable circuits is a function not only of cable shielding and the character of signals being distributed, but also of the physical separation of high-level and low-level circuits. The effectiveness of a shield is a function of the conductivity of the metal, strand sizes, percentage of coverage, and size of openings. Multiple layers of shielding, separated by dielectric material (except at connectors), are much more effective than a single layer of shielding. Although leakage power may be a very small percentage of transmitter power, if the power being carried by a cable is large, this percentage might cause a considerable interference problem to sensitive circuits.

3.3.15.3 Cable types. The principal types of cables that are utilized shall include unshielded signal wire, shielded single wire, shielded multiconductor, coaxial, unshielded twisted-pair, and shielded twisted-pair. Cables, with both single and multiple shields, in many different forms and with a variety of physical and electrical characteristics may be used. Proper selection and application of cables is instrumental in eliminating interference. Shielded cables include the following varieties:

- a. Single conductor, single shield.
- b. Double conductor, single shield.
- c. Double conductor, each conductor individually shielded.
- d. Double conductor, each conductor individually shielded and insulated with an outer single or double shield.
- e. Twisted pair, single shield.
- f. Twisted pair, double shield.
- g. Twisted 3-conductor, with single or double outer shield.
- h. Multiconductor shielded.
- i. Coaxial single shielded, double shielded, noise-free coaxial, aljak (aluminum jacketed), and heliax.
- j. Triaxial.
- k. Cables routed through solid metallic conduit.
- l. Armored over the shield and jacket.

Cables shall be specified and identified according to:

- (1) Size.
- (2) Characteristic impedance.
- (3) Attenuation.
- (4) Shielding (single, double, triple).
- (5) Power rating.
- (6) Maximum operating voltage.
- (7) Type of jacket (standard black, standard gray, low temperature black, polyethylene, fiberglass, or armor).
- (8) Type of dielectric (for example, polyethylene or teflon, solid or spiral ribbon, pressurized or unpressurized).

3.3.15.4 Required cable characteristics.

3.3.15.4.1 Low-temperature black jacket cable. The low-temperature black jacket cable shall be used for low-temperature applications. The cable shall be black in color, with white ink markings or conventional impression markings, for operation between temperature limits of -40°C and $+80^{\circ}\text{C}$. It shall be weatherproof and impervious to mechanical and electrical injury and abrasion.

3.3.15.4.2 Gray vinyl jacket. Gray vinyl jacket cable is similar to black jacket cable except that it utilizes a resinous plasticizer jacket. This cable is suitable for operation between temperature limits of -25°C and $+80^{\circ}\text{C}$.

3.3.15.4.3 Polyethylene jacket cable. Polyethylene jacket cables are usually thin in jacket cross section; they are mainly used for indoor applications. They are not for outdoor use because of poor abrasion resistance, and because polyethylene is unstable under ultra-violet light. Often, the polyethylene jacket is pigmented dark brown to filter out the sun's rays. Some commercial cables utilize heavy jackets of brown polyethylene which give added abrasion resistance as well as resistance to the sun's ultra-violet rays. This heavy-type cable is suitable for operation between temperature limits of -40°C and $+80^{\circ}\text{C}$.

3.3.15.4.4 Fiberglass jacket. A fiberglass jacket braided around the cable was developed because low-temperature vinyl and polyethylene plastic jackets cannot be used for high-temperature dielectric cables. The fiberglass braid is impregnated with four coats of high-temperature silicone varnish to seal it against moisture and to keep the braid from fraying. It is suitable for operation between temperature limits of -55°C and $+250^{\circ}\text{C}$.

3.3.15.4.5 Special noise-free cable. Special noise-free cables fulfill the need for coaxial cables that remain electrically neutral under conditions of shock and vibration. The prevention of noise is achieved for these cables by application of a semiconductive coating over the dielectric.

3.3.15.4.6 Aljak. Aljak cable has a seamless, extruded, noncontaminating aluminum jacket swaged over either teflon or polyethylene dielectric. Aljak cable has lower attenuation, smaller outside diameters, and more than 30% less weight than corresponding RG-/U types. Aljak is frequently used in applications requiring a permanent run of lightweight, rugged, completely weatherproof coaxial cable.

3.3.15.4.7 Heliax. Heli

ax cable is a gas-pressurized, large-diameter, flexible, air dielectric coaxial cable having high power-handling capabilities coupled with very low loss and low VSWR. It has a spiral polyethylene dielectric strip wrapped around a hollow inner conductor tube, and an outer conductor consisting of a flexible metal sheath. The outer sheath conductor is formed of corrugated copper-clad steel, which is first wrapped around the inner conductor assembly and then welded. The outer conductor is covered with tar and crepe filler and enclosed in a vinyl jacket. The high efficiency of heli

ax cable results from special spiral polyethylene insulation construction; this construction permits a high percentage of air in the space between inner and outer cable conductors and results in an average dielectric constant of less than 1.2. The cable is produced by a continuous process and has no joints. The inner conductor, outer conductor, and spiral insulation are continuous throughout the cable length, resulting in low VSWR and low insertion loss. The insertion loss of a typical 100 foot length of heli

ax ranges from 0.7 dB at 30 MHz, to 5 dB at 10,000 megahertz.

3.3.15.4.8 Triaxial cable. Tri

axial cable is manufactured by placing a high quality shield-braid over the jacket of standard coaxial cable, and then extruding a full thickness of vinyl jacket over all to provide weatherproofing. An important use for tri

axial cable is in test signal distribution systems, where it is necessary to provide additional shielding to minimize cross-cable interference.

3.3.15.4.9 Metal armor cable. Met

al armor is used over cable jackets for applications where additional cable protection is required because of environmental factors.

3.3.15.4.10 Commercial coaxial cables. Com

mercial coaxial cables of the RG/U series, most frequently used in the 50 ohm characteristic impedance range, are: RG-8A/U, single shield; RG-9B/U, double shield; RG-177/U, double shield; RG-59B/U, single shield; and RG-55B/U, double shield. For short, low-power, interconnecting equipment cables where line loss is not important, small RG-55B/U and RG-59B/U cables should be used. Where high radio frequencies or medium powers are involved,

and/or where line losses become important (such as within extremely low-level circuits, within antenna circuits, or within long cable runs), medium-size RG-8A/U and RG-9B/U cables should be used. Where high powers are involved, or extremely low-line losses are important, the large-sized RG-177/U cable should be used. For some interconnecting equipment applications, particularly for pulse transmission, it is necessary to use a coaxial cable with low capacitance and high impedance. In such instances, RG-62B/U cables, RG-71B/U cables, or medium sized RG-63B/U cables, which have a characteristic impedance in the 93 ohm range, should be used.

3.3.15.4.11 Flexible conduit. Flexible conduits for high- and low- voltage shielding consist of flexible metal hoses over which are wound one or more layers of wire braid. Nonconducting coverings used over the braid provide watertightness and mechanical protection. If applied tightly, they decrease contact resistance between wires comprising the braid, improving shielding effectiveness. Such coverings should be rugged and not subject to physical and chemical attack by substances with which they come into contact. They should maintain their characteristics over the anticipated range of operating temperatures.

3.3.15.4.12 Shielded conduit. Shielded conduit is used for many diversified purposes, such as:

- a. To shield wires and cables from interference.
- b. To provide a channel through which wires and cables are routed for installation and replacement in inaccessible places.
- c. To protect insulated wires and cables against mechanical damage, for example, chafing and abrasion.
- d. To keep foreign matter (moisture, oil, grease, gasoline) away from electrical conductors or their insulation.
- e. To facilitate dissipation of heat for protection of insulation.

3.3.15.4.13 Flexible shielding conduit. A flexible shielding conduit should be:

- a. An effective shield against electrical interference over the entire range of frequencies under consideration.
- b. Reasonably flexible and capable of being bent to a small radius.
- c. Rugged to withstand abuse and prolonged vibration without impairment of its electrical and mechanical properties.
- d. Watertight and airtight. The coverings used with it should be immune to attack from lubricants, coolants, anti-freeze and fuels.
- e. Capable of functioning in prescribed ambient temperatures.

3.3.16 Cable connectors. Connectors shall be used for the interconnection of power, signal, control, audio, video, pulse, and radio-frequency line carrying cables. They are made to full-fill special functions, and are required to be hermetically sealed, submersion proof, and weatherproof. They are manufactured in the straight type, angle type, screw-on type, bayonet twist and lock type, bayonet screw-on type, barrier type, straight plug-in type, and push-on type (Table XI). For interference-free design, a high conductance shielded connector with shielded cable mounting shall be provided.

3.3.17 Cable application.

3.3.17.1 General. The choice of cable is controlled by the electromagnetic use environment and physical use environment. While specific rules for cable selection require an analysis of signal levels and waveforms, the following general rules apply:

- a. Use unshielded wire for external power circuits (such as 115 Vac, 28 Vdc).
- b. Use shielded wire for multiple-ground, audio frequency and power circuits.

TABLE XI
CONNECTOR APPLICATION SUMMARY

A. NEW EQUIPMENT

<u>Connector Series</u>	<u>Disconnect Style</u>	<u>Voltage Rating</u>	<u>Characteristic Impedance</u>	<u>Freq. Range</u>	<u>Coaxial Cable Size</u>	<u>For RG-/U Cables</u>
N	Screw on Type	500V	75 ohm 50 ohm	up to 10GHz	Medium & Large	11A, 12A, 212, 213, 214, 217, 223
C	Bayonet Lock Type	1000V	50 ohm	Up to 3GHz	Medium & Large	213, 214, 217, 223, 58C
BNC	Bayonet Lock Type	250V	50 ohm 75 ohm 93 ohm	Up to 10GHz	Small	223, 58C, 59, 62, 71
SM	Screw on & Push on Types	100V	50 ohm	Up to 1GHz	Sub-miniature	174, 316

TABLE XI

CONNECTOR APPLICATION SUMMARY

B. EXISTING EQUIPMENT

<u>Connector Series</u>	<u>Disconnect Style</u>	<u>Voltage Rating</u>	<u>Characteristic Impedance</u>	<u>Freq. Range</u>	<u>Coaxial Cable Size</u>	<u>For RG-/U Cables</u>
GR-874	Push-On Type	1500V	50 Ohm	Up to 7GHz	Medium & Large	8,9,29,55,58,58A,59,62,116
UHF	Screw on Type	500V	(Non-constant)	Up to 200MHz	Medium & Small	8,9,10,11,12,13,55,58,62,63,65,71
LC	Screw On Type	500V (Modified to 10Kv)	50 Ohm	----	Large	17,18
BN	Screw On Type	5000V	50 Ohm (constant)	----	Medium & Large	8,9,10,17,18
BN	Screw On Type	250V	(Non-constant)	Up to 200MHz	Small	55,58,59,62,71
N	Screw On Type	500V	50 Ohm 70 Ohm (Constant)	Up to 10GHz	Medium & Large	5,6,8,9,10,11,12,13,14,17,18
C	Bayonet Lock Type	1000V	50 Ohm	----	Medium & Small	8,9,10,12,14,55,58
BNC	Bayonet Lock Type	250V	50 Ohm (Constant)	Up to 10GHz	Small	55,58,59,62,71

c. Use twisted-pair wiring for audio-frequency circuits grounded at a single point and for internal power circuits.

d. Use shielded twisted-pair wiring for single-point ground circuits and multiple-ground circuits where maximum electromagnetic isolation is required.

e. Use coaxial cable for transmission of RF.

f. All twisted pair circuits should be single-point grounded. Single-conductor, single-shield cable should be used for low-frequency instrumentation applications utilizing ground circuits. The double-conductor, single-shield cable shall be used for single-ended, low-frequency instrumentation applications.

3.3.17.2 Magnetic coupling. Isolation is greater for twisted-pair cable than it is for straight double conductor. Twisted-pair conductors, both shielded and unshielded, shall be used in reducing interference from magnetic coupling. For example, twisting ac power distribution leads reduces the magnetic field surrounding the wires, thus reducing pickup in circuits lying within the field. Where a signal loop is linked by an interfering magnetic field, pickup is reduced by twisting the signal wire with the ground return wire. Twisting shall be used in reducing pickup interference from three-phase power wiring and in three-wire circuits, such as those used in servo-wiring. When a twisted pair of the three is being used, each pair should be tested to determine the lead combination that produced the least pickup voltage.

should be individually shielded and have insulating sleeves over the shields. Balanced signal circuits should use twisted pair or a balanced coaxial line with a common shield. Where multiconductor twisted pair cables that have individual shields as well as a common shield are used, all shields should be insulated from one another.

c. Coaxial cables should be terminated in their characteristic impedance.

d. On shielded cables in harnesses, a common shield ground must be utilized. A clamp or heavy conductor (halo) should be used to ground all shields to the connector body. In addition, the shields shall be connected to ground through one or more connector pins.

e. Coaxial cables carrying high-level energy should not be grouped with unshielded cables or shielded cables carrying low-level signals. Although the characteristic impedance of a cable or signal circuit is normally low, the shield-circuit impedance may become appreciable if the shield is electrically long. This reduces shielding effectiveness.

f. All shielded cables should have their shields terminated in a connector with an EMI/RFI backshell to provide peripheral bonding of the shields. All connector shells should be free of nonconductive finishes and provide positive bonding and grounding with mating connectors and equipment chassis. The bonding dc resistance for all connectors shall not exceed 2.5 milliohms.

g. Grounding a number of conductor shields by means of a single wire to a connector ground pin should be avoided, particularly if the shield-to-connector or connector-to-ground lead length exceeds one inch, or where different circuits that may interact are involved. Such a ground lead is a common-impedance element across which interference voltages can be developed and transferred from one circuit to another.

h. A shielding shell should be used to shield the individual pins of a connector (Figure 59). The shell of multi-pin connectors should be connected to the shield. Coaxial lines should terminate in shielded pins. Shielded leads and drain wire within a shielded cable shall be provided in a single point ground in electronic equipment.

3.3.18 Cable shield grounding.

3.3.18.1 General. Each shield circuit should be carried individually; each should be electrically continuous and grounded at both ends. In the case of long cable shield runs, bonding of shields at intermediate locations shall be provided to reduce impedance of the shields to ground, thereby rendering the shielded circuits less susceptible to radiated or induced interference. Shields shall be electrically insulated to prevent carrying the RF currents of another. To obtain maximum RF shielding from shielded wires or coaxial lines, bond the shields to the ground plane. The shortest length of connecting strap or jumper should be used, and the bonding procedure outlined herein should be followed. If coaxial cables are used to transmit RF signals, their shields should be grounded at both the sending and receiving ends. Coaxial connectors are for this purpose; pigtail connections should be avoided. In applications where twisted-pair cables are used, the shield should be grounded at each end, and the circuit return lead should be single-point grounded.

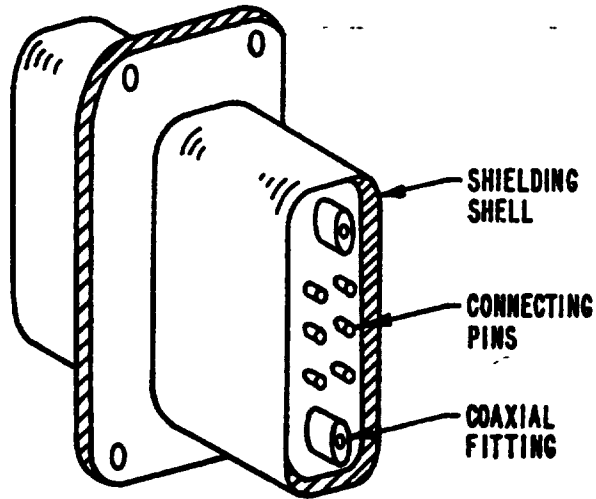

FIGURE 59. CONNECTOR WITH SHIELDING-SHELL ENCLOSURE FOR
CONNECTING POINTS

3.3.18.2 Special design features. Both multipoint and single-point ground systems offer special design features. When electronic and electrical systems are distributed over a large area, multipoint shield grounding is required for interference control. The multipoint approach allows short ground connections, provides a low impedance ground plane for system intertie points, and provides for the effectiveness of filter installations. While multiple-ground circuits are required in some RF applications, at low-frequency, low-level work with audio or servo amplifiers, single-point grounding is required. When a shielded cable in a sensitive circuit is grounded at both ends the power-frequency currents in the ground plane can induce audio-frequency interference. A single-point ground should be used where large ac currents flow in the ground plane (Figure 60). To provide additional protection, a shielded, twisted pair should be used (Figure 61). A shield should be grounded at both ends; a single return lead, however, only at one end.

3.3.18.3 Termination of shields. Shields of wire and coaxial cable shall be terminated at their connector. It is important that the connector be grounded. A direct bond for this ground can be achieved by providing metal-to-metal contact between the connector and equipment housing. Exposed unshielded leads should be short to prevent electrical coupling between circuits. Interference is caused when a shielded cable is run into a completely sealed box, and is grounded internally. The way to install a shielded RF cable is to connect the cable shield directly to the connector shell. The arrows on Figure 62 show the path that a signal or interference, picked up on the surface of the shielding, must follow to return to ground. The currents around the loop generate a field in the enclosed box. Figure 63 illustrates the correct method of introducing shielded cable into a shielded box. Interference currents may be coupled when a shielded RF cable entering an enclosure has its shield stripped back to form a grounding pigtail. Such pigtails should be avoided. Continuity of a shield shall be provided (through a pin in the connector) to a continuation of the shield inside the enclosure. The cable RF shield is a part of the shielding enclosure and should be continuous (Figure 64).

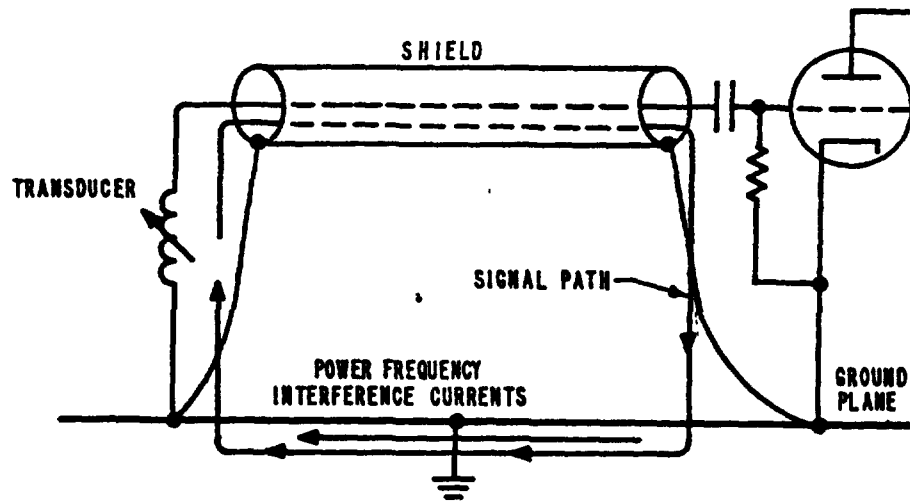

FIGURE 60. POWER FREQUENCIES COUPLED INTO LOW-LEVEL CIRCUIT USING MULTIPPOINT SHIELD GROUNDS

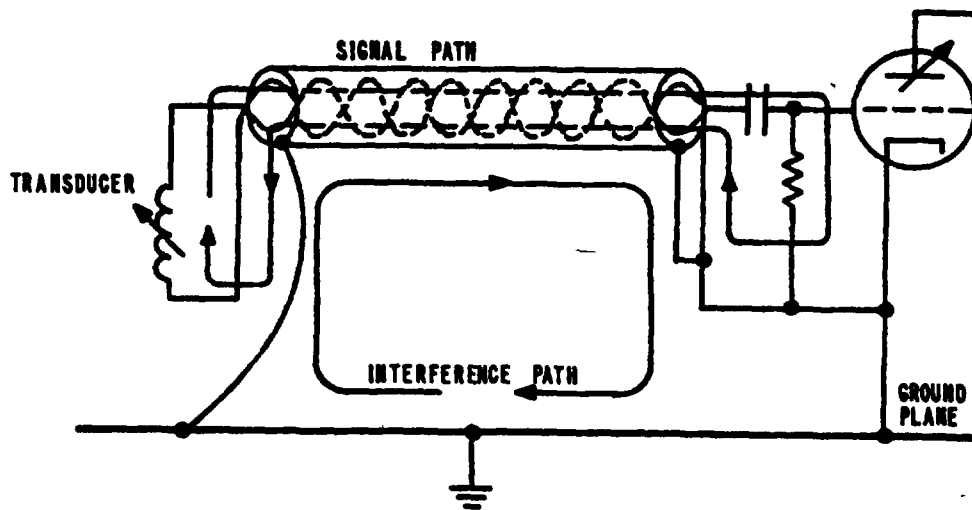

FIGURE 61. REDUCTION OF SIGNAL AND POWER FREQUENCY COUPLING BY SHIELDED, TWISTED-PAIR CABLE

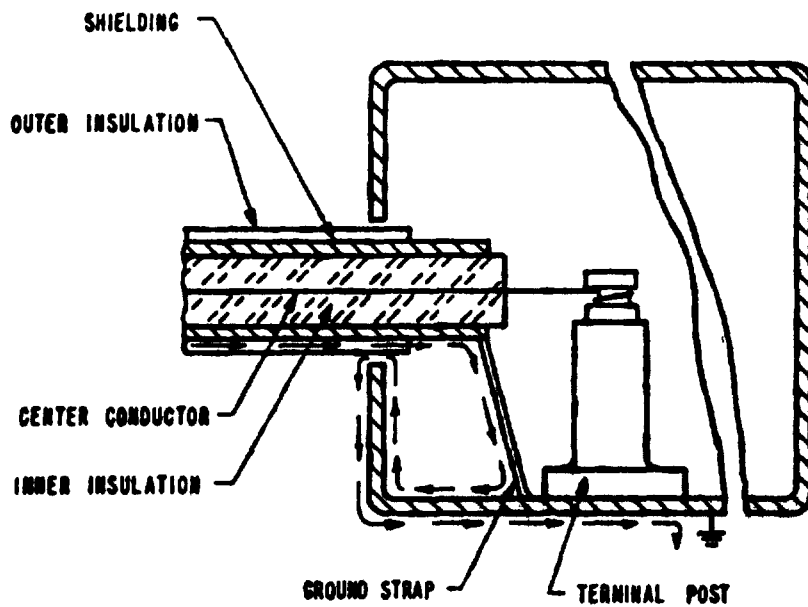

FIGURE 62. INCORRECT METHOD OF INTRODUCING SHIELDED CABLE

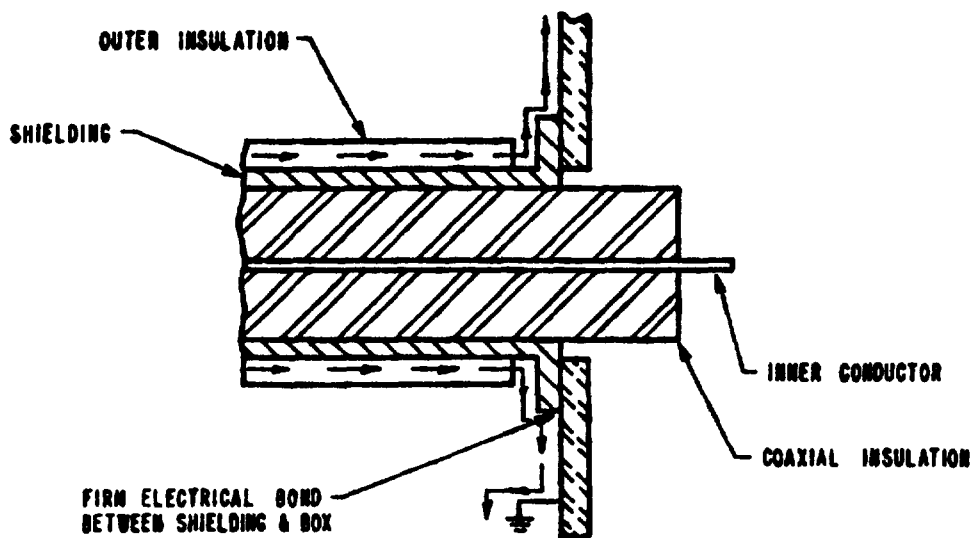

FIGURE 63 CORRECT METHOD OF INTRODUCING SHIELDED CABLE

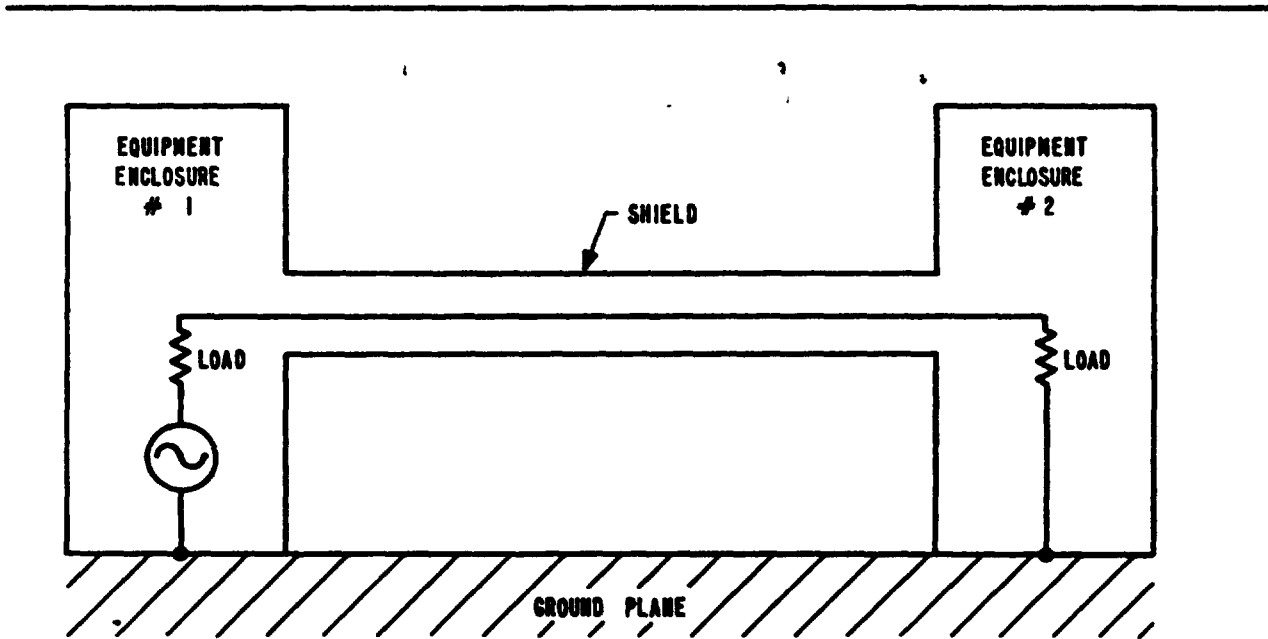
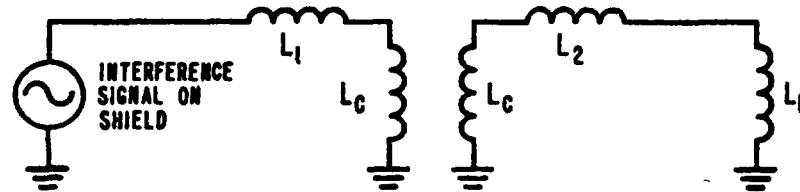
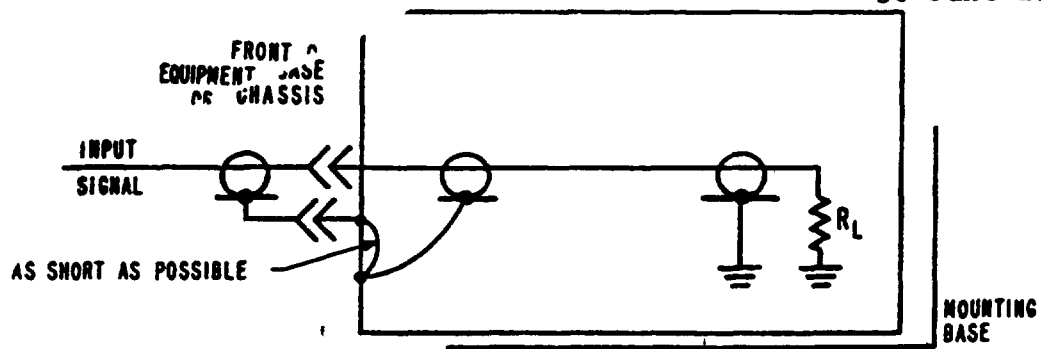
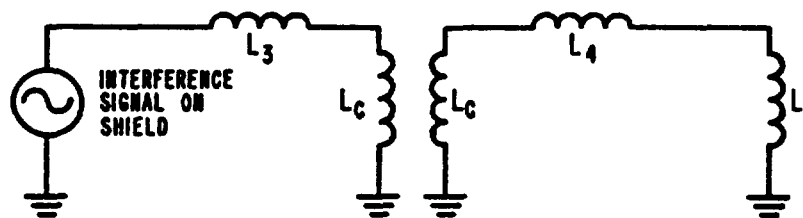
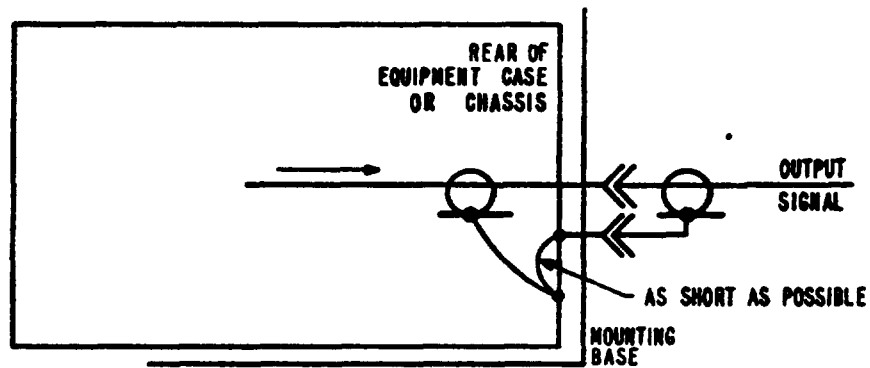

FIGURE 64. CONTINUOUS EQUIPMENT ENCLOSURE SHIELD

3.3.18.4 Isolation. During initial design stages, consideration should be given to proper location of equipment and wiring to minimize interference coupling between transmission paths. Many interference problems are eliminated by suitable physical arrangement of individual components and equipment. Sensitive equipment should be kept as far as possible from units that may be sources of electrical interference. Cabinet panels or partitions should be used to separate or shield these components. Power leads, control wiring, and other connections to sensitive equipment should not be routed close to any interference source, because of the inductive coupling that can exist between wires. Selective bundling of leads together should also be employed because of the possibility of interference coupling. If it is necessary for sensitive signal leads to pass near interference-carrying leads, relative orientation should be at right angles to minimize coupling. The distribution of power through multiple lines is recommended to reduce interference. The signal circuits should be separated from ac power circuits and any other circuits that can transfer interference to them. The use of shielded hookup wire for noisy circuit leads inside a chassis shall be used to prevent interference signals from flowing to external leads where they can be radiated. Shielded hookup wire acts as a lossy transmission line at high frequencies and introduces attenuation. In using shielded wiring, the shield braid at the end where connections have to be made should be pared back for minimum length to keep the shielding complete. The ends of the shielding should be connected directly to the chassis. The shielding should be bonded to the chassis at convenient points along the length of the lead. Leads that run side by side, or cross over each other, should have their shields bonded. Shielded electric plugs and receptacles are usually mounted on the front and/or rear of the equipment chassis, or on the mounting base. If electric receptacles are on the front of the case, the plugs should be separate units. Shield grounds should be made in accordance with Figure 65A. If electric plugs and receptacles are placed at the rear of the case, at least one unit should be securely attached to the case or chassis; the other should either be separate or securely attached to the mounting base. Shield grounds should be made in accordance with Figure 65B. In cases where a common shield-ground must be employed, such as on multishielded cables, or in harnesses having a larger number of individually shielded circuits, a clamp or bus should be used to ground all shields to the connector body, in addition to grounding them through one or more of the connector pins. To prevent discontinuity of the shield



A. ELECTRICAL RECEPTACLES IN FRONT



B. ELECTRICAL RECEPTACLES IN REAR

FIGURE 65. CABLE SHIELD BONDING

because of possible disconnect at intermediate connectors, shields should be grounded to the structure on both sides of the connector. The ground should be carried across the connector, or through a conductor pin, to ensure continuity.

3.3.19 Cable-shield bonding. Shields should be terminated at the ends of the line they are shielding. Bonding halos or interlacing straps should be used to terminate the shields. Shields should be connected to the ground plane by 1-5 inches, or less, of 0.25 or 0.5 inch wide tin-plated copper strap. The halo technique is acceptable only when a few wires are involved. The interlacing strap method should be used for a common shield ground in multishielded cables or in harnesses that have a large number of individual shields. The interlacing strap should be at least 0.25 inch wide by 0.012 inch thick and be bonded securely to the connector (Figure 66).

3.3.20 Cable routing.

3.3.20.1 Crosstalk. Crosstalk occurs when signal information being carried by one cable or circuit is coupled into adjacent circuits. Crosstalk is a function of the type, frequency, level, and rate of change of a signal circuit source; strength of the signal within the circuits experiencing interference; circuit impedances, and the degree of isolation between cable circuits. Isolation includes that afforded both by physical separation and by proper shielding. Crosstalk comprises signal information coupling induced by both magnetic and electric fields. Electric field coupling is a function of capacitance between conductors; magnetic field coupling is a function of mutual inductance between conductors. The inductive coupling between two wires depends upon the amount of flux linkage between them; the coupling between straight wires varies as the cosine of the angle between them. Thus, if it becomes necessary for signal leads to pass near interference carrying leads, they must always be as nearly at right angles to one another as to inhibit coupling. The amount of crosstalk present in a multiconductor cable is determined by the particular cable design. The design determines the geometry of the cable and such details as whether the conductors are to be parallel, paired, twisted, or shielded. In determining the geometry of the cable, proper physical grouping and routing of conductors can reduce crosstalk coupling through minimizing capacitive and inductive effects. In the routing of

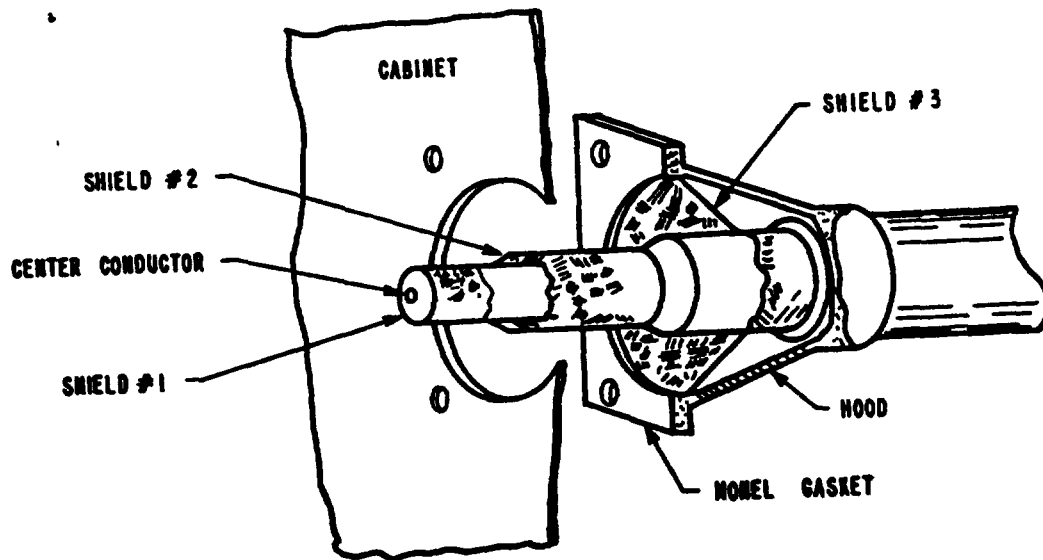

FIGURE 66. TRIAXIAL CABLE APPLICATION

circuits, high-level, low-level, and pulse circuitry should be kept separate. This physical isolation, or separation, should be maintained within interunit cabling by routing each type of signal through a different cable. To reduce mutual coupling, cables should be separated from one another and routed away from interference sources and/or susceptible equipment. Physical separation between various circuits and cables is required since:

a. Sensitive circuits are generally susceptible to crosstalk interference from high-level ac and pulse circuits.

b. Pulse circuits radiate impulse-type interference and generate strong varying magnetic fields which can couple to other circuits.

c. High-level ac circuits and cables are potential radiating interference sources for nearby circuits and cables. A typical installation employing many of the proper cabling methods discussed is shown on Figure 67. In some installations, rows and tiers of cable trays are utilized to facilitate the desired physical cable separation. Detailed planning is required prior to installation to ensure that the best overall physical circuit and cable routing is achieved.

3.3.20.2 Circuit coupling effects. Circuits may be coupled by either mutual impedance or mutual admittance. These mutual elements may be resistances, capacitances, inductances, or any series or parallel combination of these elements. The degree of coupling will be greatly reduced by proper grounding, bonding and shielding. The mutual impedance of a common ground return, which can result from inadequate bonding, may become a major source of interference. Unless there is perfect shielding, there is always capacitance to metallic objects that will provide a return path for RF current through one of the circuits. Whenever there is a direct connection and return path between two circuits, a conduction current may flow between the circuits. The return path may be another metallic lead, mutual capacitance or a common ground return. The magnitude of the resulting current depends on the potential difference between points of entry and exit in the exciting circuit and the total loop impedance between these two points.

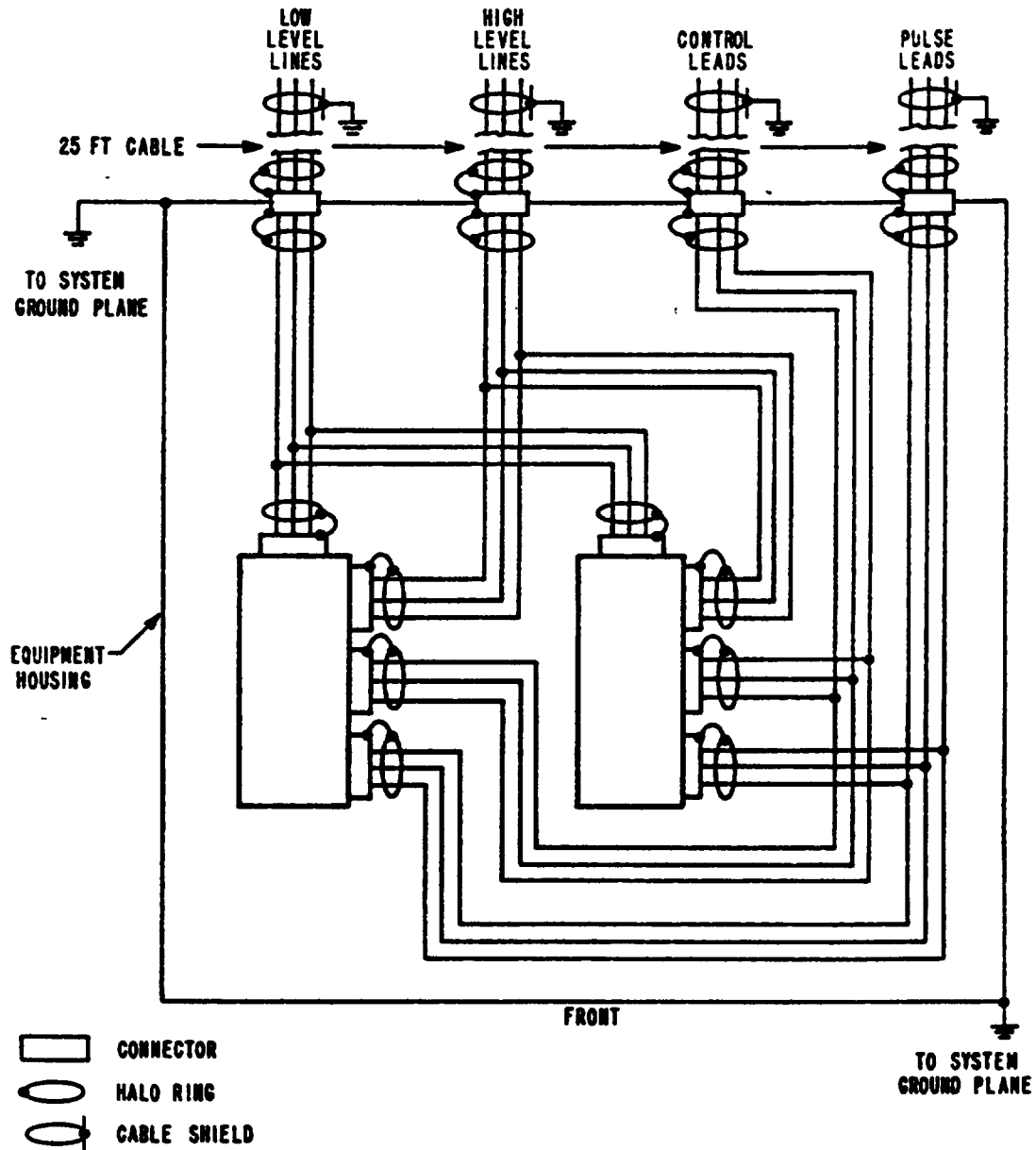

- NOTES :
1. MODULES BONDED TO CABINET.
 2. ALL LINES INDIVIDUALLY SHIELDED AND INSULATED.
 3. LINES CROSS AT RIGHT ANGLES TO EACH OTHER TO EFFECT MAXIMUM INTERFERENCE REDUCTION.

FIGURE 67. TYPICAL CABLING METHODS

3.3.20.2.1 Radiation coupling. Radiation coupling will vary with the circuit path configuration and the frequency of the signal being transmitted. Generally, the degree of coupling increases as frequency increases. Such an increase may also result from increased antenna efficiency because any length of wire can act as an antenna and will be a more efficient radiator or receiver as its length approaches one-half wavelength. Leakage may take place by wave penetration through the braid of a cable shield. Penetration occurs because of the finite resistivity of braid material and openings in the shielding. Leakage can also occur at the cable connector because of poor contact between the shield and the connector. Magnetic fields are a problem primarily at low frequencies. Little reflection from shields occurs, and reduction of the field must be accomplished by absorption in the shielding material. If high-permeability shielding material is used, the shield will act as a low-impedance flux path and will absorb energy and divert the field. The shield should therefore be of high-enough permeability and sufficient thickness, to maintain the flux densities in it at levels below its saturation. Precautions should be taken to prevent the exposed portion of a shield from intermittently contacting another uninsulated portion of shielded cable, as might occur during vibration. This can be done by rigidly tying down and lacing cables.

3.3.20.2.2 Magnetic coupling. The largest percentage of interference coupling encountered results from magnetic coupling --energy transferred from one circuit to another through mutual inductance. Current flowing in a wire in one circuit can induce voltage in a second circuit. The configuration of two circuits is shown in Figure 68. Circuit 1 on Figure 68 represents the circuit causing the interference, while circuit 2 represents the circuit that has the interference voltage induced in it. I_1 is the current that is producing the magnetic field; Z_{01} and Z_{02} are the source impedances; Z_1 and Z_2 represent load impedances, e_0 is the interfering signal; and L_M is the mutual inductance between the circuits. This mutual inductance is directly proportional to the length for which the circuits are adjacent (l), and inversely proportional to the spacing between them (d). The voltage induced in the secondary of the equivalent transformer is proportional to the frequency, the mutual inductance, and the current in the source circuit. The interference voltage

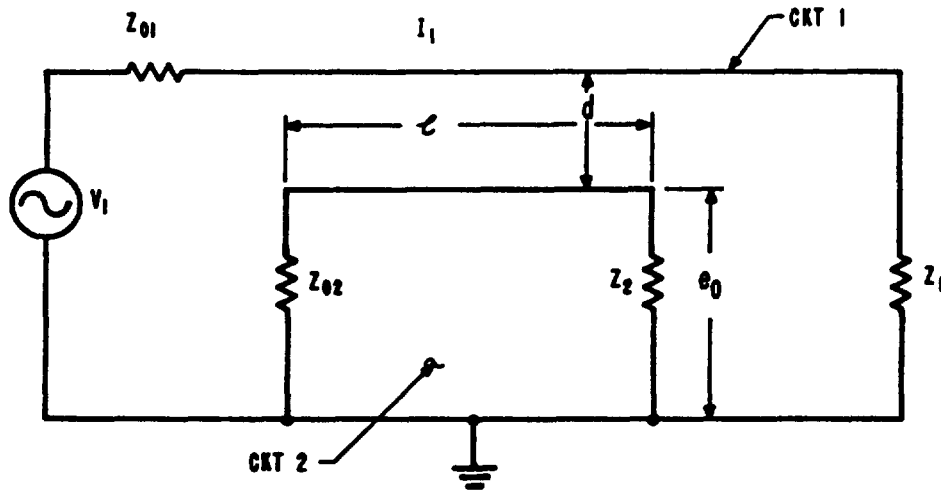

A. PHYSICAL CIRCUIT

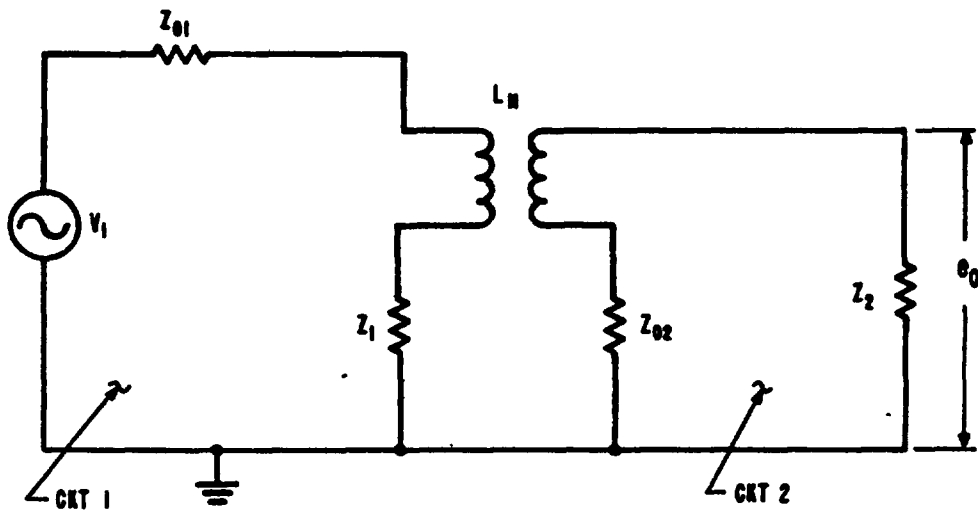

B. EQUIVALENT CIRCUIT

FIGURE 68. MAGNETIC COUPLING

is the induced voltage multiplied by the ratio between the sensitive circuit load and the total impedance of the secondary:

$$e_0 = k f L_M I_1 \frac{Z_2}{Z_2 + Z_{02}} \quad (14)$$

Any change in circuit parameters or configuration that changes the flux linkages changes the voltage induced. The physical separation of the circuits reduces voltage by lowering the flux density in the pickup loop. In addition, circuit configurations can be employed in which equal and opposite voltages are induced in the circuit. At frequencies below 5 kHz, a twisted-pair will provide over 20 dB of magnetic coupling reduction, while copper braid shielding will provide practically none. Conventional copper braid shielding for containment of magnetic fields becomes more effective as the frequency is increased above 5 kHz. Ferrous shielding increases the shielding effectiveness below 5kHz. For effective magnetic decoupling throughout the spectrum, twisted-pair conductors enclosed by conventional copper braid shield are usually employed. The shielding effectiveness of copper braid is less than 10 dB up to 20 kHz; it increases to 40 dB at 1 MHz, and to 100 dB at 40 MHz. The effectiveness of twisted-pair wires depends, to a large extent, on the uniformity and number of the twists employed; unshielded twisted-pair of 18 turns/foot is more effective for reducing magnetic coupling than is shielded twisted-pair of 6 turns/foot. Table XII gives minimum twists/foot for common conductors.

3.3.20.2.3 Electrostatic coupling. Electrostatic coupling occurs when a voltage in a circuit causes a current in another circuit. The mechanism of the coupling is through the mutual capacitance between the circuits (see Figure 69). Among the physical factors that determine the magnitude of the interference signal are the proximity of the wires, the length of their common run, their distance from the ground plane, the frequency of the source signal, and the ratio of the impedance in the two circuits. Although magnetic coupling does not take place when source current is not flowing, interference may still take place in the case of electrostatic coupling.

3.3.20.3 Transient response.

TABLE XII. WIRE TWIST

<u>Guage Number</u>	<u>Two Conductor (twists/foot)</u>	<u>Three Conductor</u>	<u>Four Conductor</u>	<u>Six Conductor</u>	<u>Eight Conductor</u>
6	4	3	2	1	1
8	5	4	3	2	1.5
10	6	4	3	2.5	2
12	7	5	4	3	2
14	8	6	4	3	2.5
16	10	7	5	4	3
18	12	8	6	6	4
20	16	12	8	8	6
22 & above					

This listing represents the minimum number of twists/foot for wire routing and distribution systems.

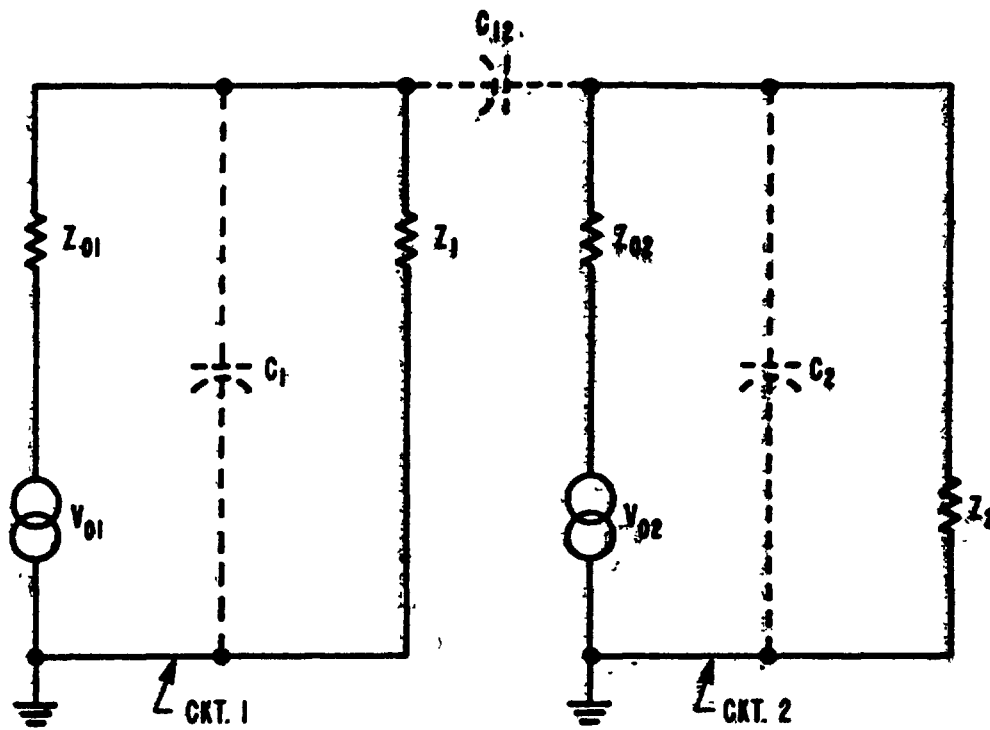

FIGURE 69. CAPACITIVELY-COUPLED CIRCUITS

3.3.20.3.1 Circuit analysis. Circuits, such as relay switching circuits, give rise to transients. A typical circuit of this type is shown on Figure 70. Circuit 1 of Figure 70 is activated by a step-voltage of magnitude V_0 at time $t = 0$. To simplify the transient response analysis, both circuits should be assumed to have the same capacitance to ground and the same parallel combination of load and source resistance. The following is the expression for the output voltage:

$$e_0(t) = \frac{1}{2}V_0 (R_p/R_{01}) \left[\epsilon^{-\frac{\gamma t}{\tau}} - \epsilon^{-\frac{t}{\tau}} \right] \quad (15)$$

where: R_p = parallel combination of load and source resistances of either circuit

R_{01} = source resistance in circuit 1

$\tau = R_p C_1$

$\gamma = \frac{\alpha - 1}{\alpha + 1}$

$\alpha = 1 + \frac{C_1}{C_{12}}$

The waveform of this voltage is shown on Figure 71. The maximum value of e_0 and the total energy (W) coupled into circuit 2 are given by the following expressions:

$$e_{\max} = V_0 \cdot \frac{R_p}{R_{01}} \cdot \frac{\gamma^{\alpha/2}}{\sqrt{\alpha^2 - 1}} \quad (16)$$

$$W = \frac{1}{4} \frac{V_0^2}{R_2} \cdot \left(\frac{R_p}{R_{01}} \right)^2 \cdot \frac{\tau}{\alpha(\alpha-1)} \quad (17)$$

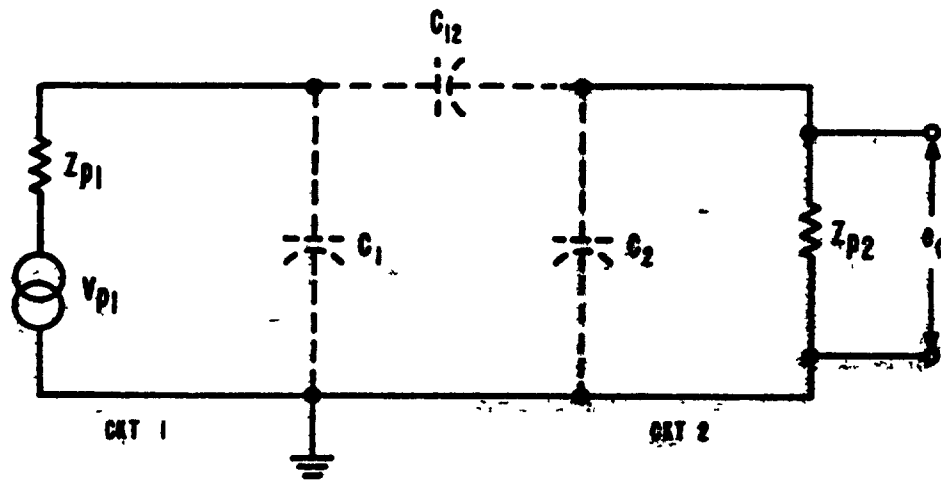

FIGURE 70. EQUIVALENT CIRCUIT FOR DERIVATION OF COUPLED SIGNAL

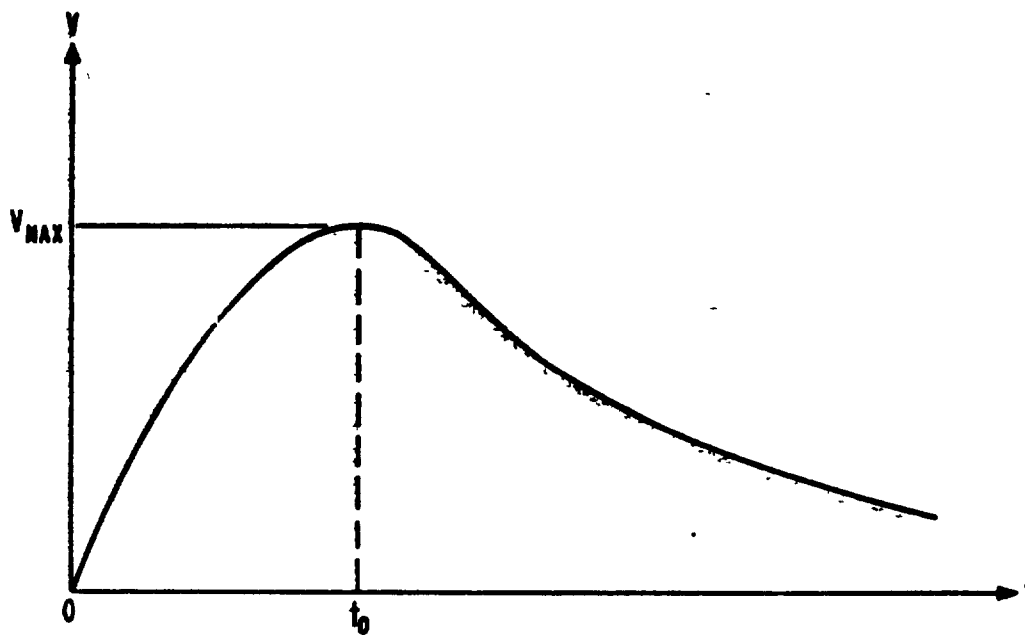

FIGURE 71. COUPLING SIGNAL RESULTING FROM STEP VOLTAGE

The listing shows the advantages gained by using the shielded configuration in dealing with circuits involving dc signals and with circuits involving switching that generates transients. It indicates that hazards due to functions, and burnout due to coupled energy is more likely to occur in circuits involving dc switching. The comparisons shown in the listing serve to exemplify a possible means of predicting interference. It is possible to apply the same approach to other types of cable circuits; for example, printed boards and circular conductors. In addition, it is possible to make comparisons using such fixed parameters as cost, power handling capability and length of time that the interference signal is above a fixed threshold. To minimize capacitive crosstalk, the insulations should be of low dielectric constant, its thickness should be increased or, if possible, the two circuits should be routed in different layers (color groups) of multilayer cable.

3.3.20.4 Common-impedance cabling elements. Interference signals originating in one unit of an electronic complex may be conducted and distributed to other units. A single signal, ground, or shield circuit may branch out to several district units. This branching out may recur repeatedly per system intertie conditions. As this recurs, a network forms with common circuit elements. These common elements act as common impedances for currents originating in branches outside the common element, and voltages are developed across the common impedances. To reduce interference, it is necessary to eliminate as many common impedance circuit and cabling elements as possible. Such action requires careful design consideration within signal and ground circuits, but is readily accomplished within shield circuits. Common-impedance signal-circuit elements are best eliminated at the design stage by use of isolation elements such as individual amplifiers, cathode followers, transformers, or filters. Circuits that utilize a single-point grounding philosophy usually are not subject to this consideration, as such circuits usually do not consist of branching networks, involving common impedance elements. Undesirable effects of common-impedance ground-circuit elements are effectively eliminated if an adequate ground plane, extending throughout the system, is utilized for the ground return circuits. While the ground plane itself is a common impedance element, its impedance must be low to preclude interference voltages developing across it of sufficient level to affect mutual ground circuits. Common impedance in shield elements can be effectively eliminated by utilizing the ground system and properly grounding all shield tie points. A ground loop should be used to ground shields at each end for the reduction of interference.

3.3.20.5 Power cabling. The three phases of each delta-connected transmission system and the three phases and the neutral wire of each four-wire, wye-connected transmission system, should be twisted to form one cable. Twisting the wires together cancels the electric and magnetic fields produced by the 120 degree phase-differential voltages and currents for either type of connection. Twisting the three-phase wires and the neutral wire in the four-wire, wye-connection cancels the magnetic field produced by the in-phase third-harmonic currents that flow in each phase and add algebraically in the neutral. These third harmonic currents are generated when the iron cores of transformers or motors are driven to near saturation or operate in the nonlinear portion of the magnetization curve. The design of electrical equipment in which the iron cores are purposely driven into saturation is often undertaken where space and weight limitations are at a premium and the duty factor is low. Functional equipment performance degradation is a possibility because of harmonic voltages and currents on the power lines. The wires should have as many twists per foot as possible. Where two wires are connected in parallel to form one phase of the three-phase system, a total of six wires are used and twisted to form a cable. Each conductor of a pair that represents one power phase of this six-wire cable should be diametrically opposite to its paralleling mate.

3.3.20.5.1 Separation of motor loads from signal loads. A common source of interference is caused by commutation in dc motors and slip-rings in ac motors. Sensitive circuits are particularly susceptible to voltage transients generated by these sources. Separate power lines for sensitive circuits should be used to prevent conducted interference.

3.3.20.5.2 Separation of utility lines from signal loads. Utility lines may create undesirable paths for conducted interference signals and are capable of radiating interfering signals to nearby areas. Separate supply lines should be used to preclude the entry of such conducted interference into signal loads. A delta-to-wye hookup to provide 120 volts for single-phase signal loads and utilities is recommended. The lines supplying each load should be tied to a separate point in the junction box to isolate the circuits. Individual grounds, returning to the earth ground, should be used.

3.3.20-5-3 Placement of conduit and wireways. Low-level cables should be separated from other cables. Installation plans should identify high-level and low-level cables for special routing. Cables used for pulse signals should be kept in separate wireways. The use of metal conduit is recommended in the installation of cables where sensitivity of circuits requires maximum isolation. Separation of power lines and signal lines is mandatory. Where cables and wireways are tied into junction boxes, separate boxes should be used for power and signal lines. If cables and wireways are routed into a single junction box, separate tie points and internal shielding between lines are required. Closed wireways and conduit, suitably grounded, are required.

3.3.20.5.4 Balanced and unbalanced circuits. Balanced lines provide signal isolation. A circuit is considered balanced only when it fulfills all of the following conditions:

- a. The wires constituting the circuit have equal and opposite current flow at any specified point.
- b. The circuit is free of primary ground plane grounding.
- c. Both lines of the circuit are of the same gauge, length, and metallic material.
- d. Both wires have similar high dielectric insulation.
- e. Both wires are similarly twisted with respect to each other.
- f. Metallic splices and terminations are secured electrically.

3.3.20.5.5 Signal circuits and pulse leads. All signal circuits should be isolated from power or other circuits. Cabling low level signal circuits with ac power circuits should be prohibited. Leads that carry pulse waveforms should be run through separate connectors. When any pulse lead passes through a connector in a way that involves a discontinuity in the coaxial structure on the shielded lead (for example, when a pulse lead center-conductor and shield are attached to separate pins of a connector), a direct connection to ground should be provided for the ground lead of the shield in the connector. A

suitable low-impedance connection should be provided for the ground lead of the shield in the connector. A suitable low-impedance connection should be provided by the use of an extremely heavy pin, or by the use of several pins in parallel, preferably distributed circumferentially about the pin attached to the pulse lead center-conductor. The pulse lead should be shielded to prevent interference transfer to other leads. Additional protection should be provided by using RF filters to bypass unwanted interference components as required.

3.3.20.6 Waveguides. Where waveguides are used in electronic systems, interference can be generated by the creation of spurious modes of propagation as well as by leakage at a waveguide junction. The generation of spurious modes should be resolved through proper guide excitation, dimensioning, and junction design. The installation of waveguides can also cause spurious modes because improper support in a vibration environment, particularly where a flexible guide is used, can provide conditions whereby spurious modes can be generated. Prevention of interference from being generated as a result of leakage at a waveguide junction is predicated upon continuous conductive contact around the junction periphery. Good pressure sealing is also required as provided by a conductive gasket. The same basic waveguide seal should be used in applications ranging from a waveguide, feeding minute signals to a sensitive receiver, to a waveguide carrying the output of a megawatt transmitter. This universal seal should be designed for the high-power application and be capable of heat dissipation consistent with the power rating of the waveguide sections it joins. At the high frequencies, wavelengths diminish and short, physical discontinuities provide RF leakage. Crevices and cracks in a seal become electrically significant. The seal must be designed so that no leakage will occur at operating frequencies within the spectrum that is anticipated. Practical hardware will normally introduce discontinuities at a sealed joint. The design engineer should specify a seal that provides complete and continuous integrity. The waveguide seal should provide an RF short circuit over the mating area for its operating frequency range. The standard choke flange should prevent leakage. This flange is effective when modified by the addition of a woven-metal gasket in a separate outer groove to provide electromagnetic continuity between the flange faces. The seal should consist of a metal plate (matching the waveguide flange face) that has raised contacts adjoining the waveguide opening. Adjacent to this

electrical sealing area should be a contoured conductive rubber gasket, molded into the metal plate. The gasket deforms when the waveguide flange faces are closed down. The combined effect is a seal that accomplishes the dual purpose of RF leakage prevention and/or pressure sealing. Belt securing is vital to accomplish these tasks.

3.3.21 Equipment mounting.

3.3.21.1 General. Shielding and bonding of equipment are required at the cabinet level. In the mounting of equipment, the cabinet should provide a bonding connection between the individual chasses and the ground plane, as well as an intermediary bonding intertie between the cable trays and the ground plane.

3.3.21.2 Rack bonding. The equipment rack provides the means of maintaining electrical continuity between such items as rack-mounted chasses, panels, and the ground plane. It also serves as the electrical intertie for the cable trays. An equipment cabinet, with the necessary modifications to provide such bonding, is shown on Figure 74. Bonding between the equipment chassis and the rack is achieved at the equipment front panel and the rack right-angle bracket. This bracket should be grounded to the unistrut horizontal slide that is welded to the rack frame. The lower surfaces of the rack should be treated with a conductive protective finish to facilitate bonding to the ground plane mat. The ground stud at the top of the rack must bond the cable tray to the rack structure. Figure 75 illustrates a typical bonding installation. The cable tray is bonded to the cable chute; the cable chute is bonded to the top of the cabinet; the cabinet is bonded to the flush-mounted grounding insert (which is welded to the ground grid); and the front panel of the equipment is bonded to the rack or cabinet front-panel mounting surface. Nonconductive finishes must be removed from the equipment front panel before bonding. The joint between equipment and cabinet shall provide a dual purpose: that of achieving an electromechanical bond and that of preventing interference leakage. Conductive gaskets should be used around the joint to ensure that metal-to-metal contact is provided. Equipment in a shock-mounted tray must be bonded across its shock mounts to the rack structure. Connector mounting plates should use conductive gasketing to improve the chassis bonding. If chassis removal from the rack is required, a one inch wide braid with a vinyl sleeving should be provided to bond the back of the chassis to the rack.

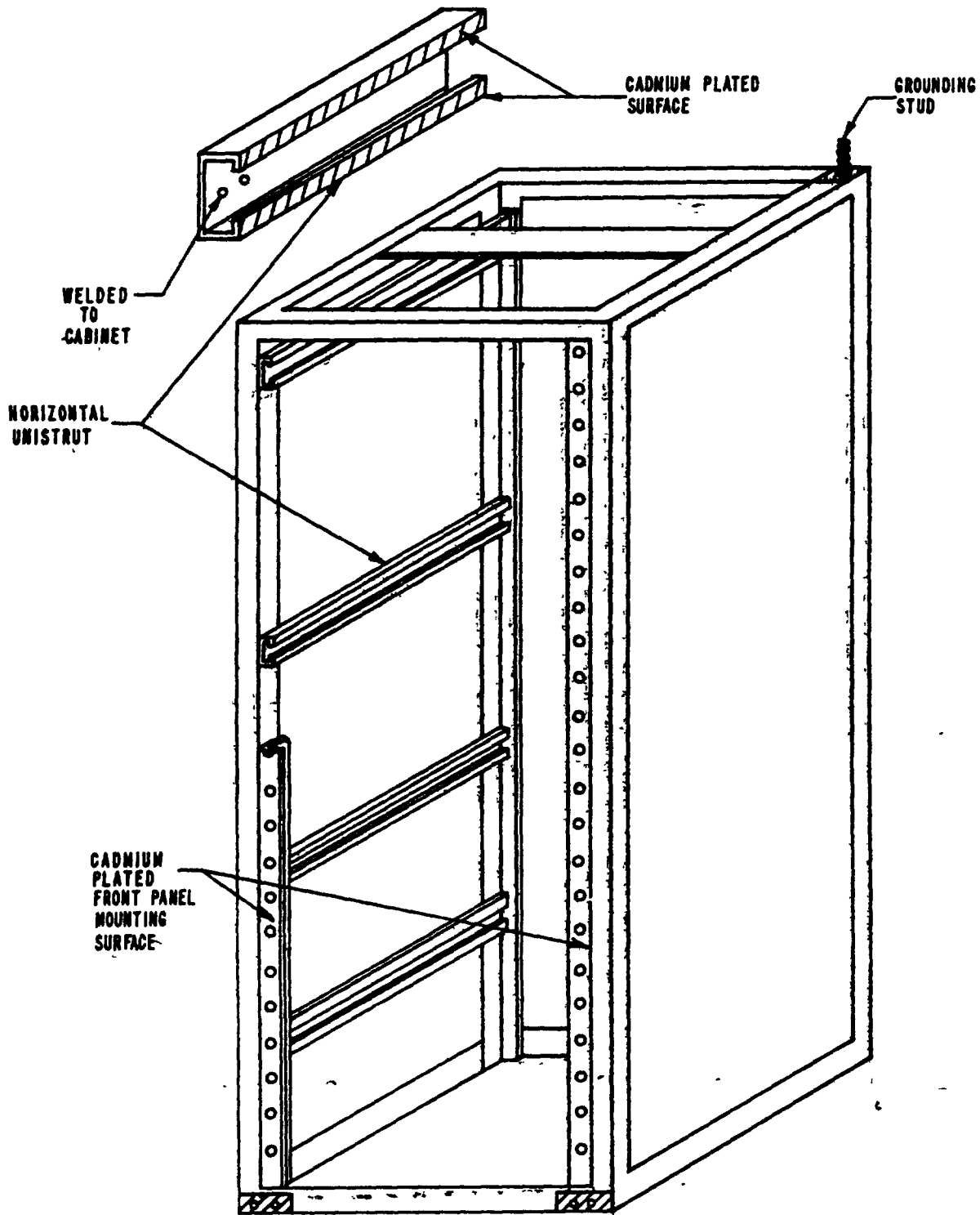

FIGURE 74. CABINET BONDING MODIFICATIONS

3.3.21.3 Cabinet shielding and equipment location.

Provide shielding at the cabinet level to contain interference generated by cabinet-mounted equipment and to protect such equipment from external electromagnetic fields, especially when unshielded off-the-shelf equipment must be integrated into a secure electronic complex. The interference characteristics of such equipment will cause electromagnetic compatibility problems unless external shielding is considered. The procedures for establishing the cabinet design are the same as for any type of shielded enclosure. All joints should be designed to prevent leakage. Equipment should be located to avoid interference problems. Equipment housings should have a mating surface to ground within a prepared well and they shall be connected together by means of beryllium-copper straps. These bondings to beryllium-copper straps shall not be less than one inch in width and have a width-to-length ratio of at least 1:5. One ground strap should be used for each equipment housing. The following are the requirements:

a. Communications receivers and transmitters should be located to that their antenna lead-in wiring is short.

b. Dynamotors, inverters, motor-alternators, and electric motors should be located remotely from receivers and positioned to prevent their interference fields from coupling to the receiver lead-in wiring.

c. All electrical machinery should be remote from openings in equipment structures. To prevent interference fields from radiating directly to external antennas, shields are required over apertures.

d. Radar modulators and transmitters should be located remote from communication receivers.

e. Auxiliary power units should be located remote from openings in the equipment.

f. Low-level circuitry should be located remote from high-level circuitry, and shielding, bonding and grounding principles employed.

Custodian:
Army-EL

Preparing Activity
Army-EL
Project EMCS-A050

10. APPENDIX A

CHARACTERISTICS OF MATERIAL

10.1 This appendix covers reference tables for information on electromagnetic characteristics of materials.

TABLE A-I. REFLECTION LOSS

	Electric Field (a) dB			Magnetic Field (a) dB			Plane Wave (b, d) dB		
	Copper	Aluminum	Iron	Copper	Aluminum	Iron	Copper	Aluminum	Iron
60 Hz	279	---	241	22	--	-1	150	148	113
1,000 Hz	242	---	204	34	--	10	138	136	100
10 kHz	212	---	174	44	--	8	128	126	90
150 kHz	177	175	---	56	54	19	117	114	79
1 MHz	152	150	116	64	62	28	108	106	72
15 MHz	117	115	83	76	74	42	96	94	63
100 MHz	92	90	64	84	82	56	88	86	60
1,500 MHz	c	---	c	c	--	c	76	74	57
10,000 MHz	c	---	c	c	--	c	68	66	60

- (a) For signal source 12 inches from shield. Wave impedance much greater than 377 ohms. (For distances much greater or smaller than 12 inches, recalculate the reflection loss using the formulas given in text.)
 (b) If penetration loss is less than 10dB total reflection loss must be corrected by use of B-factor.
 (c) At these frequencies, the fields approach plane waves with an impedance of 377 ohms.
 (d) Signal source greater than 2λ from the shield.

TABLE A-II. B-FACTORS IN ELECTRIC, MAGNETIC, AND PLANE WAVE
FIELDS OF SOLID COPPER AND IRON SHIELDS

Shield Thickness (mils)	60 Hz	100 Hz	1 kHz	10 kHz	100 kHz	1 MHz
Copper, $\mu = 1$, $G = 1$, Magnetic Fields						
1	-22.22	-24.31	-28.23	-19.61	-10.34	-2.61
5	-21.30	-22.07	-15.83	- 6.98	- 0.55	+0.14
10	-19.23	-18.59	-10.37	- 2.62	+ 0.57	0
20	-15.35	-13.77	- 5.41	+ 0.13	- 0.10	
30	-12.55	-10.76	- 2.94	+ 0.58	0	
50	- 8.88	- 7.07	- 0.58	0		
100	- 4.24	- 2.74	+ 0.50			
200	- 0.76	+ 0.05	0			
300	+ 0.32	+ 0.53				
Copper, $\mu = 1$, $G = 1$, Electric Fields and Plane Waves						
1	-41.52	-39.31	-29.38	-19.61	-10.33	-2.61
5	-27.64	-25.46	-15.82	- 6.96	- 0.55	+0.14
10	-21.75	-19.61	-10.33	- 2.61	+ 0.57	0
20	-15.99	-13.92	- 5.37	+ 0.14	- 0.10	
30	-12.73	-10.73	- 2.90	+ 0.58	0	
50	- 8.81	- 6.96	- 0.55	+ 0.14		
100	- 4.08	- 2.61	+ 0.51	0		
200	- 0.62	+ 0.14	0			
300	+ 0.41	+ 0.58				
Iron, $\mu = 1000$, $G = 0.17$, Magnetic Fields						
1	+ 0.95	+ 1.23	- 1.60	- 1.83		
5	+ 0.93	+ 0.89	- 0.59	0		
10	+ 0.78	+ 0.48	+ 0.06			
20	+ 0.35	+ 0.08	0			
30	+ 0.06	- 0.06				
50	0	0				
Iron, $\mu = 1000$, $G = 0.17$, Electric Fields and Plane Waves						
1	-19.53	-17.41	- 8.35	- 1.31		
5	- 6.90	- 5.17	+ 0.20	0		
10	- 2.56	- 1.31	+ 0.36			
20	+ 0.16	+ 0.54	0			
30	+ 0.58	+ 0.42				
50	+ 0.13	0				

TABLE A-III. TOTAL REFLECTION LOSS IN ELECTRIC FIELD (WAVE IMPEDANCE MUCH GREATER THAN 377 OHMS) AT BOTH SURFACES OF SOLID STEEL AND COPPER SHIELDS

Frequency	dB Loss ^a					
	Steel			Copper		
	Distance From Source to Shield					
	24 in.	165 ft.	1 mile	24 in.	165 ft.	1 mile
30 Hz	241	203	173	282	243	213
60 Hz	233	195	165	273	235	205
100 Hz	226	188	158	266	228	198
500	205	167	137	245	207	177
1 kHz	196	158	128	236	198	168
10 kHz	166	128	98	206	168	138
50 kHz	145	107	77 ^b	185	147	117 ^b
150 kHz	131	92	—	171	132	—
1 MHz	108	69 ^b	—	146	108 ^b	—
3 MHz	91	—	—	132	—	—
10 MHz	79	—	—	116	—	—
15 MHz	75	—	—	111	—	—
100 MHz	56 ^b	—	—	86 ^b	—	—

^aIf loss is less than 10 dB, the total reflection loss must be corrected by use of B-factor.

^bAt these frequencies, the wave impedance approaches that of plane waves ($r > \lambda$), and the values for plane wave reflection loss should be used.

TABLE A-IV. TOTAL REFLECTION LOSS IN MAGNETIC FIELD (WAVE IMPEDANCE MUCH SMALLER THAN 377 OHMS) AT BOTH SURFACES OF SOLID STEEL AND COPPER SHIELDS

Frequency	dB Loss ^a					
	Steel			Copper		
	Distance From Source To Shield					
	24 in.	165 ft.	1 mile	24 in.	165 ft.	1 mile
30 Hz	-1	24	53	25	63	93
60 Hz	-1.4	26	56	28	66	96
100 Hz	-1.2	30	59	30	69	99
500 Hz	1.4	36	66	37	76	106
1 kHz	3.2	39	69	40	79	109
10 kHz	11	49	79	50	89	119
50 kHz	18	56	86 ^b	57	96	129 ^b
150 kHz	23	60	—	62	100	—
1 MHz	32	70 ^b	—	70	109 ^b	—
3 MHz	37	—	—	75	—	—
10 MHz	43	—	—	80	—	—
15 MHz	46	—	—	82	—	—
100 MHz	60 ^b	—	—	90 ^b	—	—

^aIf loss is less than 10 dB, the total reflection loss must be corrected by use of B-factor.

^bAt these frequencies, the wave impedance approaches that of plane waves ($r \gg \lambda$), and the values for plane wave reflection loss should be used.

TABLE A-V. TOTAL REFLECTION LOSS IN PLANE WAVE FIELD
(WAVE IMPEDANCE EQUALS 377 OHMS) AT BOTH
SURFACES OF SOLID STEEL AND COPPER SHIELDS

Frequency	dB Loss	
	Steel	Copper
30 Hz	113	153
60 Hz	110	150
100 Hz	108	148
500 Hz	101	141
1 kHz	98	138
10 kHz	88	128
50 kHz	81	121
150 kHz	76	116
1 MHz	70	108
3 MHz	66	103
10 MHz	61	98
15 MHz	60	96
100 MHz	58	88
1000 MHz	51	78
1500 MHz	56	76
10 GHz	58	68

- a If loss is less than 10 db, the total reflection loss must be corrected by use of B-factor.
- b Comparison of these values with those on Table VII indicate very close agreement since these losses are for plane waves.

TABLE A-VI. LOSS OF STEEL AND COPPER SHIELDS AT
30 Hz to 10 GHz

Frequency	dB Loss		
	1 Mil Steel	50 Mil Steel	7 Mil Copper
30 Hz	0.2	9	0.13
60 Hz	0.3	13	0.18
100 Hz	0.3	17	0.23
500 Hz	0.7	37	0.52
1 kHz	1.0	53	0.74
10 kHz	3.2	161	2.34
50 kHz	7.5	374	5.23
150 kHz	13	649	9
1 MHz	28	1395	23
3 MHz	45	2245	40
10 MHz	75	3740	74
15 MHz	82	4080	90
100 MHz	106	5280	234
1000 MHz	236	11800	740
1500 MHz	130	6490	905
10 GHz	106	5280	2340

TABLE A-VII. EXAMPLES FOR CALCULATING SHIELDING EFFECTIVENESS
OF SOLID-METAL SHIELD

	10kHz — 10 Mils					
	Magnetic Field		Electric Field		Plane Wave	
	Copper	Iron	Copper	Iron	Copper	Iron
Reflection	44.2	8.0	212.0	174.0	128.0	90.5
Absorption	3.6	43.5	3.3	43.5	3.3	43.5
B-Factor	-2.6	0	-2.6	0	-2.6	0
Total Loss (dB)	45.2	51.5	212.7	217.5	128.7	134.0

	60 Hz — Magnetic					
	1 Mil		10 Mils		300 Mils	
	Copper	Iron	Copper	Iron	Copper	Iron
Reflection	22.4	-0.9	22.4	-0.9	22.4	-0.9
Absorption	0.03	0.33	0.26	3.34	7.80	100.0
B-Factor	-22.2	+0.95	-19.2	+0.78	+0.32	0
Total Loss (dB)	0.23	0.38	3.46	3.22	30.52	99.1

	10kHz - 30 Mils - Magnetic		1kHz - 10 Mils - Magnetic	
	Copper	Iron	Copper	Iron
Reflection	44.20	8.0	34.2	0.9
Absorption	10.02	130.5	1.06	13.70
B-Factor	-0.58	0	-10.37	+0.06
Total Loss (dB)	54.80	138.5	24.89	14.66

	10 Mils — Copper					
	150 kHz			1 MHz		
	Electric	Plane Waves	Magnetic	Electric	Plane Waves	Magnetic
Reflection	176.8	117.0	56.0	152.0	108.2	64.2
Absorption	12.9	12.9	12.9	33.4	33.4	33.4
B-Factor	+0.5	+0.5	+0.5	0	0	0
Total Loss (dB)	190.2	130.4	69.4	185.4	141.6	97.6

TABLE A-VIII. MESH, WIRE AND APERTURE SIZES FOR TYPICAL SCREENING MATERIALS

Mesh	Wire Diameter (inches)	Size of Opening (inches)
8 x 8	0.028	0.097
8 x 8	0.032	0.093
8 x 8	0.035	0.090
8 x 8	0.047	0.078
8 x 8	0.063	0.062
10 x 10	0.025	0.075
10 x 10	0.032	0.068
10 x 10	0.035	0.065
10 x 10	0.041	0.059
12 x 12	0.018	0.065
12 x 12	0.023	0.060
12 x 12	0.028	0.055
12 x 12	0.035	0.048
12 x 12	0.041	0.042
14 x 14	0.017	0.054
14 x 14	0.020	0.051
14 x 14	0.025	0.046
14 x 14	0.032	0.039
16 x 16	0.016	0.0465
16 x 16	0.018	0.0445
16 x 16	0.028	0.0345
18 x 18	0.017	0.0386
18 x 18	0.020	0.0356
18 x 18	0.025	0.0306
20 x 20	0.014	0.0360
20 x 20	0.016	0.0340
20 x 20	0.020	0.0300
22 x 22	0.015	0.0305

TABLE A-IX, MESH, WIRE AND APERTURE SIZES FOR SCREENING MATERIALS TESTED

Metal	Mesh Size	Wire Diameter (mils)
Monel	No. 10	18
Copper	No. 12	20
Aluminum	No. 16	20
Galvanized steel	1/4-inch x 1/4-inch	30
Galvanized steel	1/2-inch x 1/2-inch	30
Perforated steel ^a	1/8-inch diameter holes	on 3/16-in centers
Perforated aluminum ^a	1/4-inch diameter holes	on 5/16-inch centers
Perforated aluminum ^b	7/16-inch diameter holes	on 5/8-inch centers
Aluminum honeycomb ^c	1/4-inch segregated cells	

^a60 mils thick

^b37 mils thick

^c1 inch thick

TABLE A-X. CHARACTERISTICS OF TYPICAL PERFORATED SHEET STOCK

Hole Size (inches)	Hole Centers (inches)	Holes (square inch)	Open Area (%)
0.014	0.034	890	13
0.014	0.042	665	10
0.018	0.045	504	13
0.018	0.055	380	10
0.020	0.034	890	27
0.020	0.040	650	20
0.020	0.042	665	20
0.020	0.045	504	15
0.020	0.049	500	15
0.020	0.055	380	12
0.020	0.085	144	4
0.020	0.089	148	4
0.023	0.040	650	26
0.023	0.049	500	20
0.024	0.037	710	32
0.024	0.040	650	28
0.024	0.045	504	22
0.024	0.046	542	24
0.024	0.049	500	21
0.024	0.055	380	17
0.024	0.059	331	14
0.024	0.063	292	13
0.024	0.079	160	8
0.024	0.079	186	8
0.024	0.085	144	6
0.024	0.088	148	7
0.024	0.110	82	4
0.024	0.110	94	4
0.025	0.045	504	28
0.025	0.055	380	20

continued

TABLE A-X, CHARACTERISTICS OF TYPICAL PERFORATED SHEET (cont'd)

Hole Size (inches)	Hole Centers (inches)	Hole (square inch)	Open Area (%)
0.025	0.059	331	17
0.025	0.085	144	7
0.025	0.088	148	8
0.028	0.048	420	26
0.028	0.059	331	20
0.028	0.102	94	6
0.028	0.102	110	7
0.030	0.059	331	23
0.030	0.102	94	7
0.030	0.102	110	8
0.032	0.071	465	35
0.032	0.059	331	26
0.032	0.102	110	9
0.033	0.059	331	27
0.034	0.059	331	29
0.035	0.059	331	31
0.036	0.055	330	37
0.036	0.055	380	37
0.036	0.059	331	33
0.036	0.069	245	24
0.036	0.099	119	12
0.036	0.119	70	7
0.036	0.119	82	8
0.037	0.079	186	22
0.039	0.069	245	30
0.039	0.074	213	26
0.039	0.079	186	23
0.039	0.099	119	15
0.039	0.108	98	12

TABLE A-X. CHARACTERISTICS OF TYPICAL PERFORATED SHEET STOCK (cont'd)

Hole Size (inches)	Hole Centers	Holes (square inch)	Open Area (%)
0.039	0.130	59	7
0.039	0.130	68	8
0.039	0.237	20	3
0.041	0.079	186	25
0.043	0.079	186	28
0.043	0.091	140	21
0.045	0.079	186	30
0.045	0.091	136	22
0.048	0.079	186	33
0.048	0.091	140	25
0.048	0.079	186	36
0.050	0.102	110	21
0.050	0.119	82	16
0.050	0.138	60	12
0.050	0.177	36	7
0.050	0.201	28	6
0.052	0.079	186	38
0.052	0.091	140	23
0.052	0.102	110	23
0.052	0.119	82	17
0.052	0.138	60	13
0.052	0.157	46	10
0.053	0.091	140	30
0.053	0.110	94	21
0.055	0.091	140	34
0.055	0.110	94	23
0.055	0.126	64	15
0.055	0.157	46	11
0.055	0.189	32	8

TABLE A-X. CHARACTERISTICS OF TYPICAL PERFORATED SHEET STOCK (cont'd)

Hole Size (inches)	Hole Centers (inches)	Holes (square inch)	Open Area (%)
0.057	0.099	119	31
0.059	0.092	136	37
0.059	0.099	119	33
0.059	0.102	110	30
0.059	0.119	82	23
0.059	0.157	46	13
0.059	0.170	35	10
0.059	0.170	40	11
0.059	0.205	27	8
0.061	0.102	111	30
0.063	0.102	110	34
0.063	0.119	82	26
0.063	0.126	72	23
0.063	0.177	36	11
0.063	0.205	26	9
0.063	0.217	24	8

20. APPENDIX B

SHIELDING CHARACTERISTICS OF MATERIAL

20.1 This appendix covers reference figures for information on shielding characteristics and techniques.

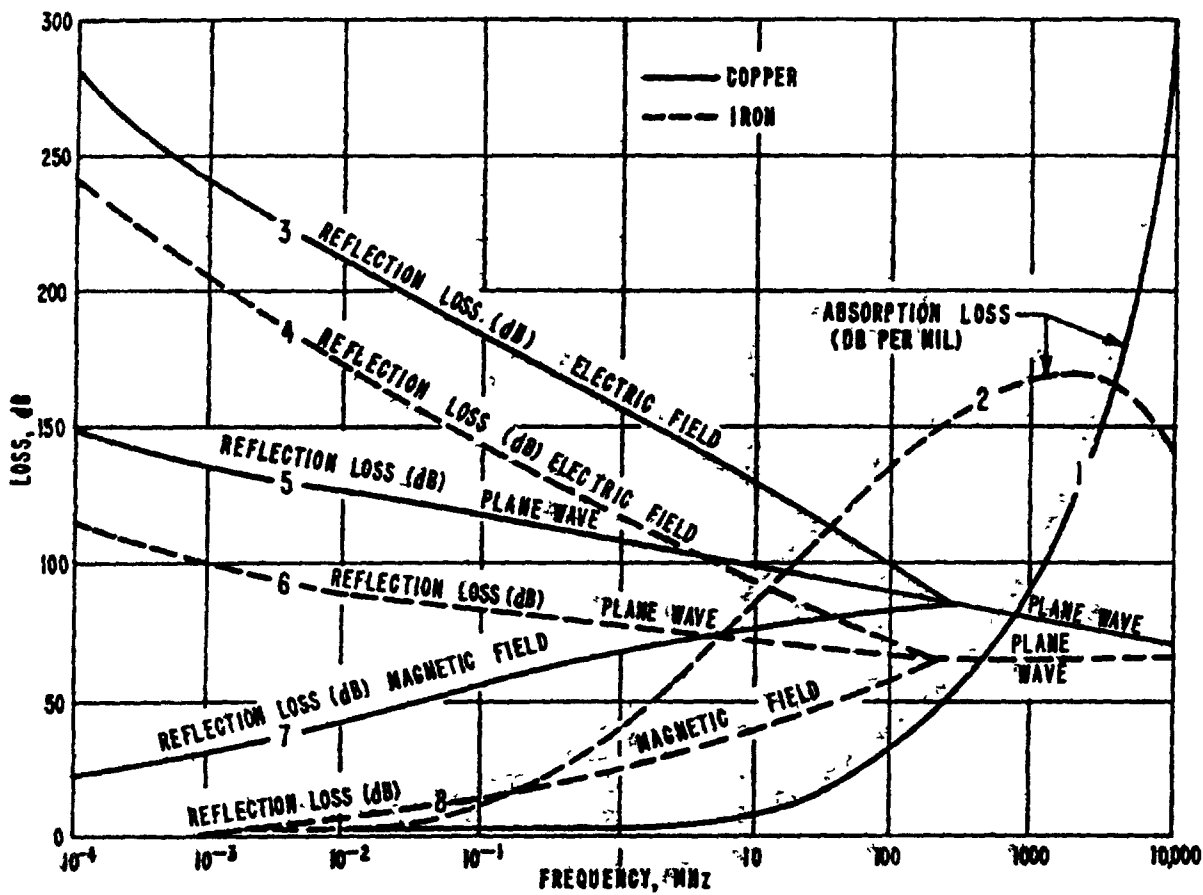

- 1 AND 2 - ABSORPTION LOSS PER MIL THICKNESS OF METAL
- 3 AND 4 - REFLECTION LOSS - ELECTRIC WAVES
- 5 AND 6 - REFLECTION LOSS - PLANE WAVES
- 7 AND 8 - REFLECTION LOSS - MAGNETIC FIELDS

SHIELDING EFFECTIVENESS - REFLECTION LOSS + ABSORPTION LOSS

$$SE = R + A$$

- FOR COPPER: ELECTRIC FIELD; SE = CURVE 3 + CURVE 1 X "t" (THICKNESS IN MILS)*
- MAGNETIC FIELD; SE = CURVE 7 + CURVE 1 X "t" (THICKNESS IN MILS)*
- PLANE WAVE; SE = CURVE 5 + CURVE 1 X "t" (THICKNESS IN MILS)*
- FOR IRON; ELECTRIC FIELD; SE = CURVE 4 + CURVE 2 X "t" (THICKNESS IN MILS)*
- MAGNETIC FIELD; SE = CURVE 8 + CURVE 2 X "t" (THICKNESS IN MILS)*
- PLANE WAVE; SE = CURVE 6 + CURVE 2 X "t" (THICKNESS IN MILS)*

* IF THE SHIELD IS ELECTRICALLY THIN (A LESS THAN 10 DB). THEN CALCULATE THE B FACTOR AND INCLUDE IN THE SHIELDING EFFECTIVENESS EQUATION (SE = R + A + B)

FIGURE B-1 SHIELDING EFFECTIVENESS IN ELECTRIC, MAGNETIC AND PLANE WAVE FIELDS OF SOLID COPPER AND IRON SHIELDS (FOR SIGNAL SOURCE 12 INCHES FROM SHIELD AT 100 Hz TO 10 GHz)

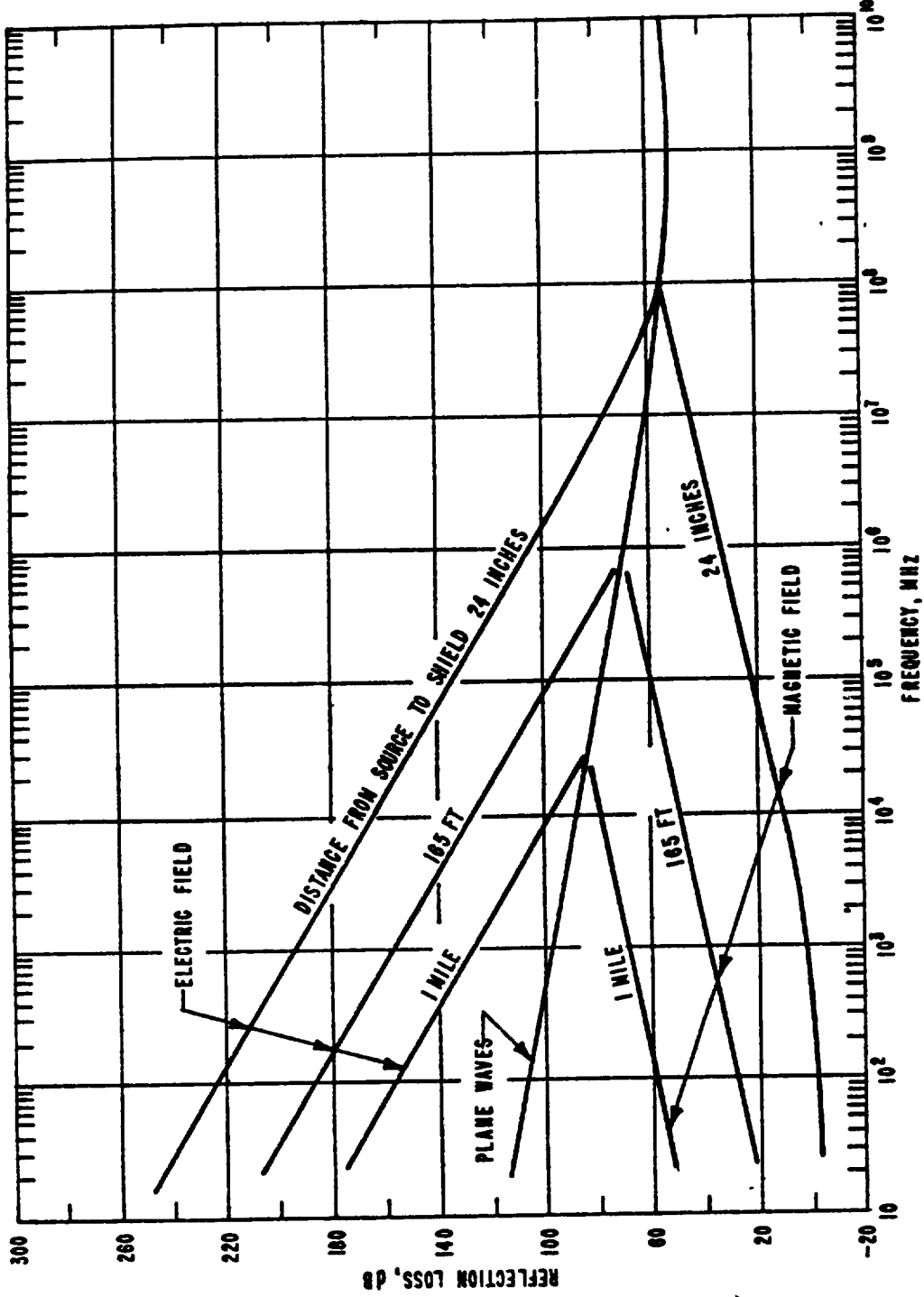

FIGURE B-2. TOTAL REFLECTION LOSS AT BOTH SURFACES OF A SOLID STEEL SHIELD

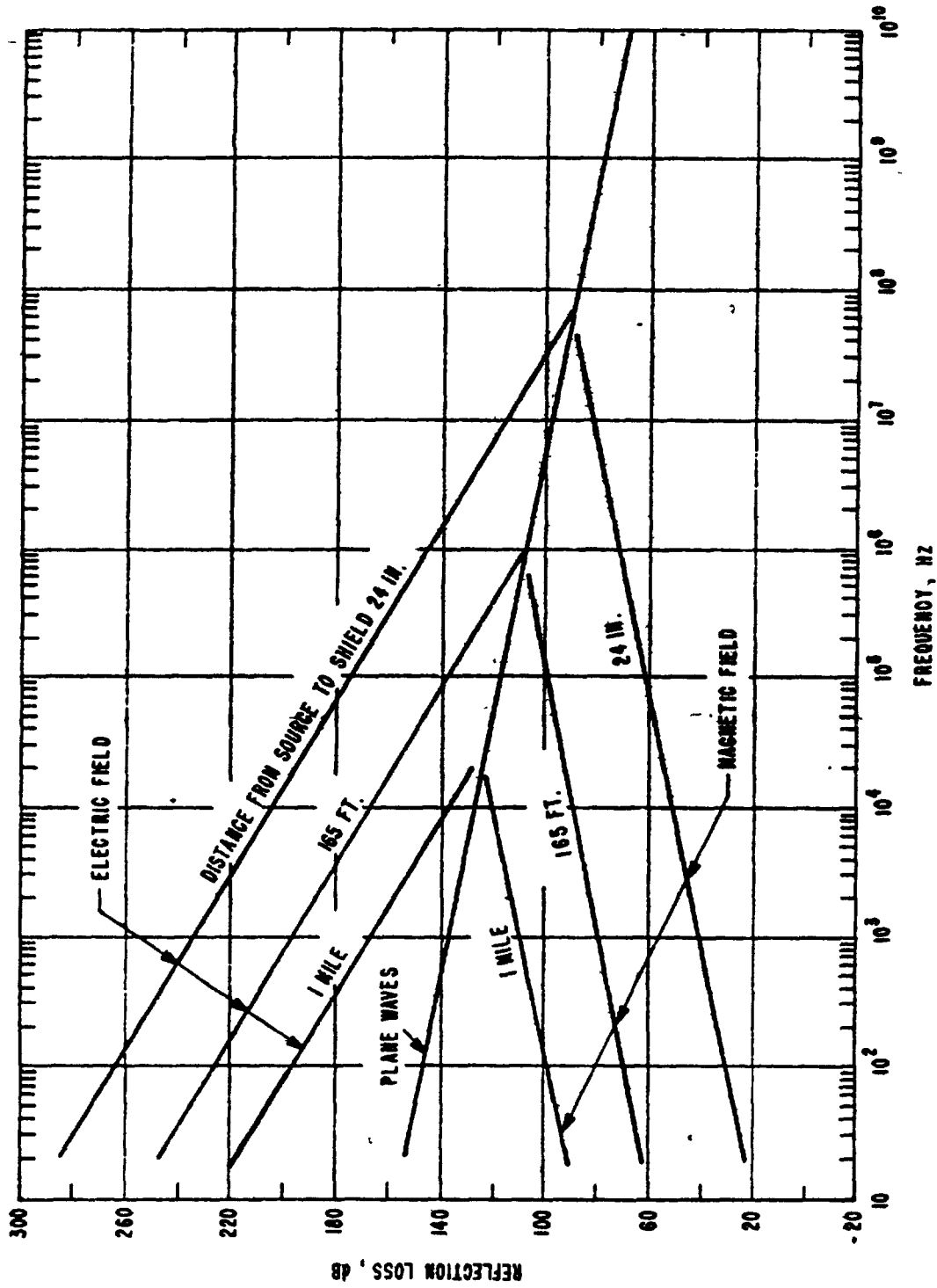

FIGURE B-3 TOTAL REFLECTION LOSS AT BOTH SURFACES OF A SOLID COPPER SHIELD

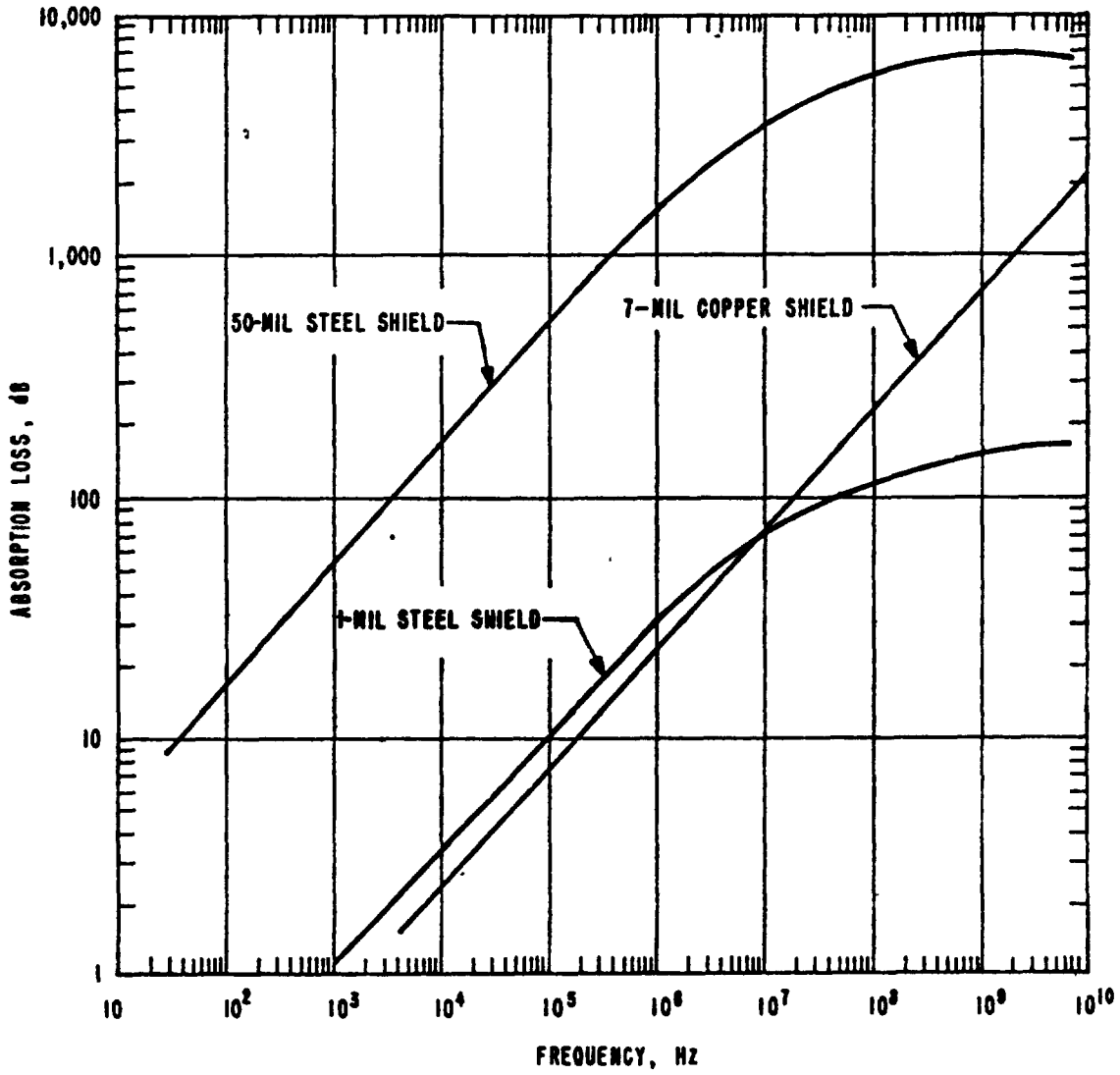
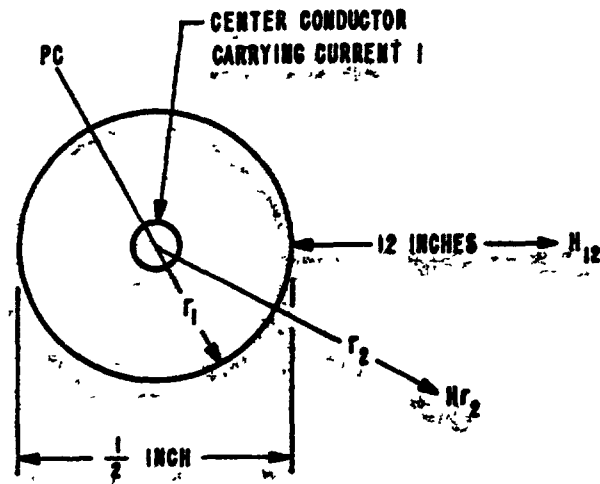

FIGURE B-4 ABSORPTION LOSS FOR STEEL AND COPPER SHIELDS AT 30 Hz TO 10,000 MHz



r_1 : RADIUS TO SHIELD OF CABLE
 r_2 : RADIUS TO POINT IN SPACE
 PC : RADIATED INTERFERENCE POWER AT CENTER
TRANSMISSION CABLE
 H_{12} : MAGNETIC FIELD INTENSITY AT ANTENNA
 H_{r_2} : MAGNETIC FIELD INTENSITY AT POINT IN SPACE

FIGURE B-5. SHIELDING FOR TRANSMISSION CABLE

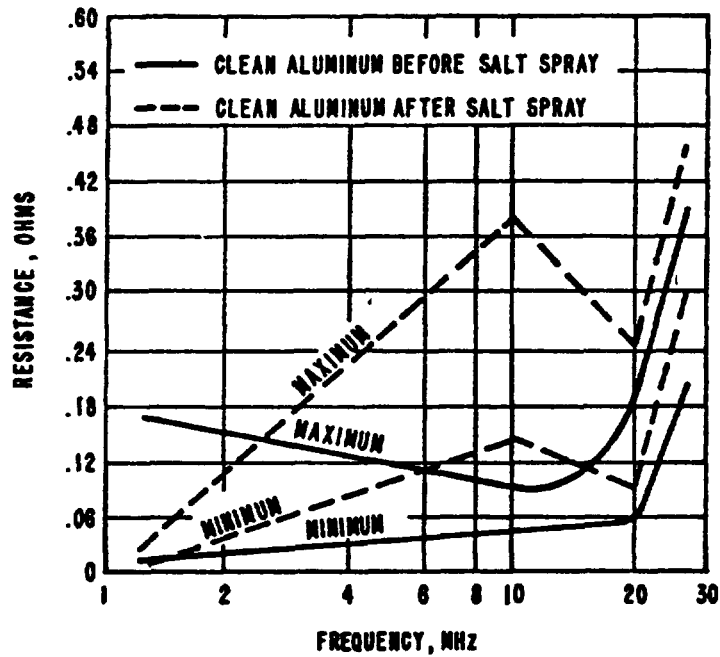

FIGURE B-6. VALUES OF EQUIVALENT SERIES RF RESISTANCE OF UNCOATED ALUMINUM SECTIONS BEFORE AND AFTER 64-HOUR SALT SPRAY TEST

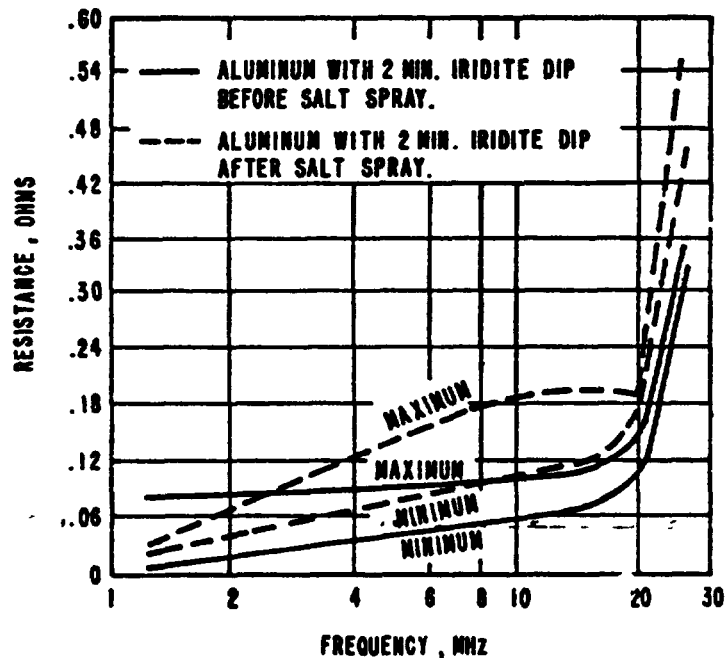

FIGURE B-7. VALUES OF EQUIVALENT SERIES RF RESISTANCE OF CHROMATE-TREATED ALUMINUM SECTIONS BEFORE AND AFTER 64-HOUR SALT SPRAY TEST

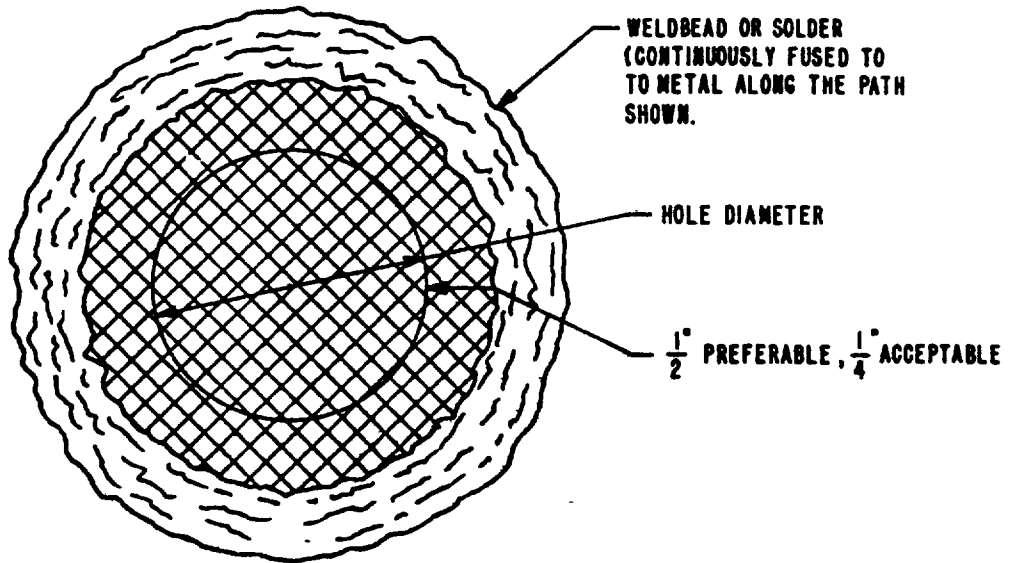

FIGURE B-8 TYPICAL WELDED SCREEN INSTALLATION OVER A VENTILATION APERTURE

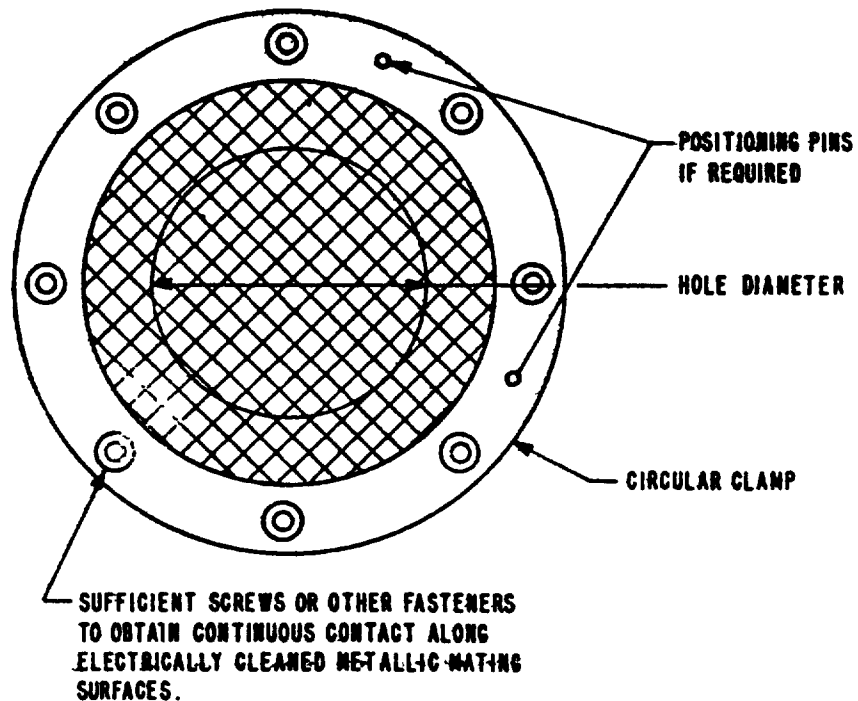

FIGURE B-9. TYPICAL CLAMPED SCREEN INSTALLATION OVER A VENTILATION APERTURE

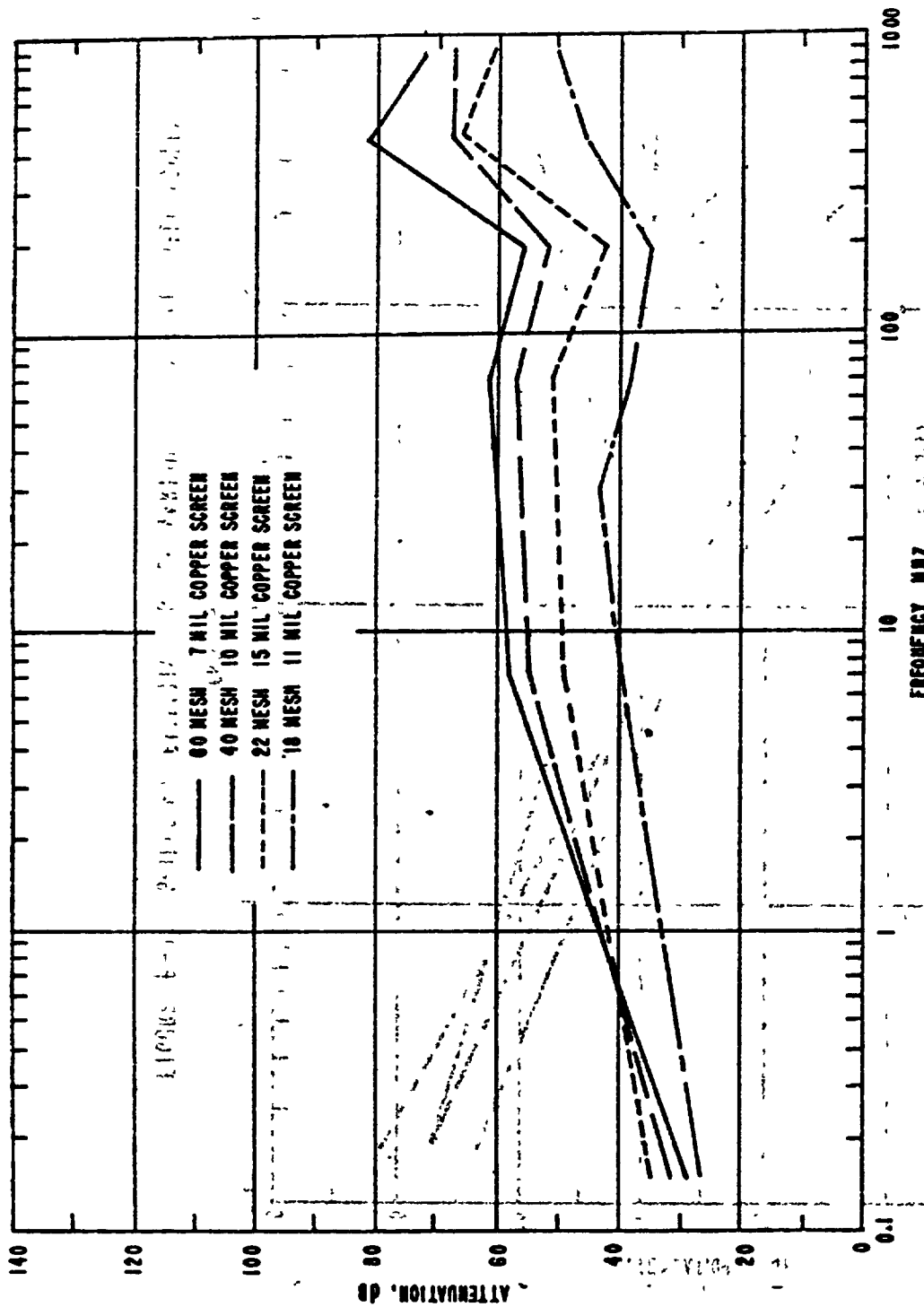

FIGURE B-10. SHIELDING EFFECTIVENESS OF VARIOUS COPPER SCREENS

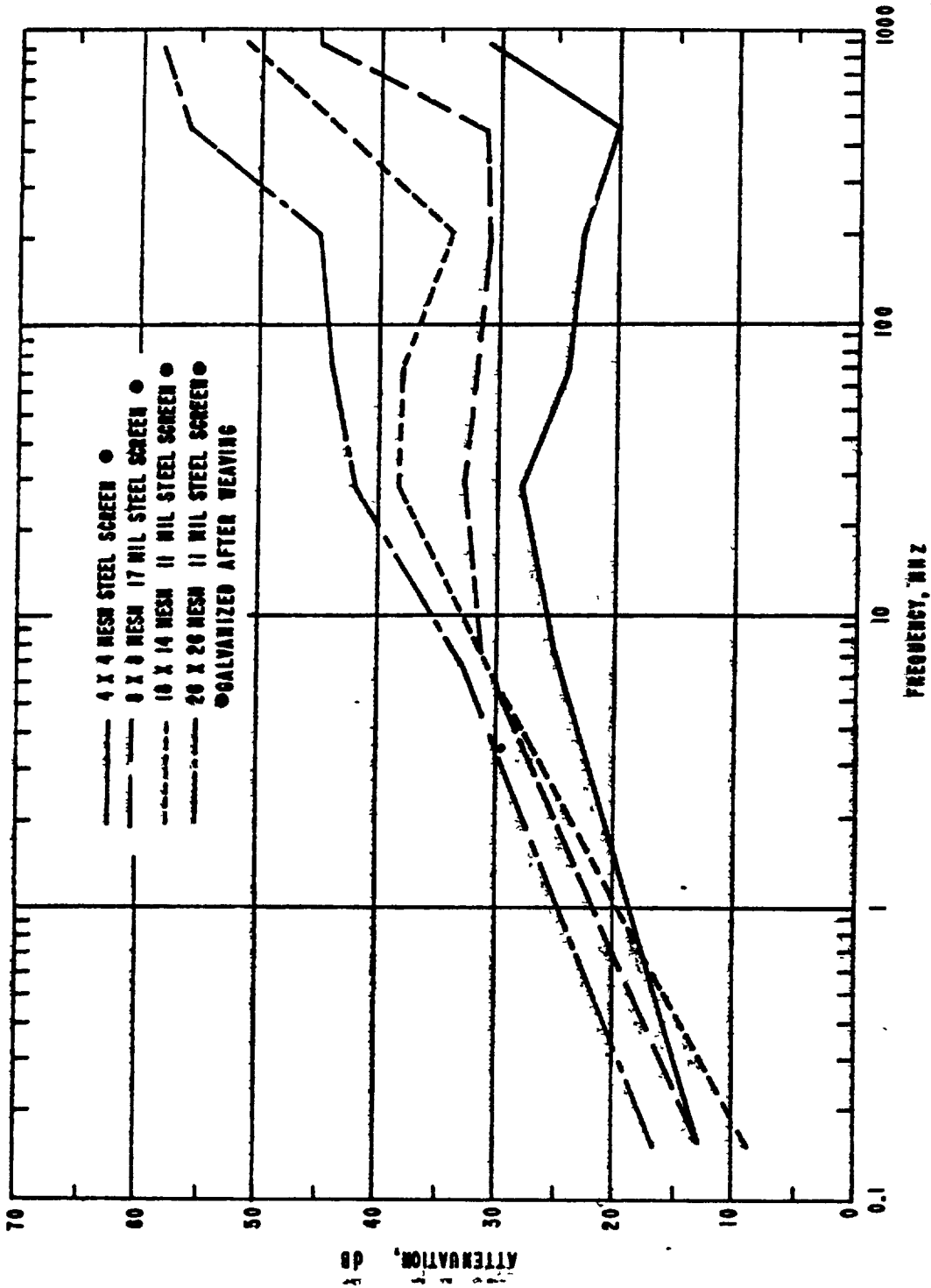

FIGURE 8-11. SHIELDING EFFECTIVENESS OF VARIOUS GALVANIZED STEEL SCREENS

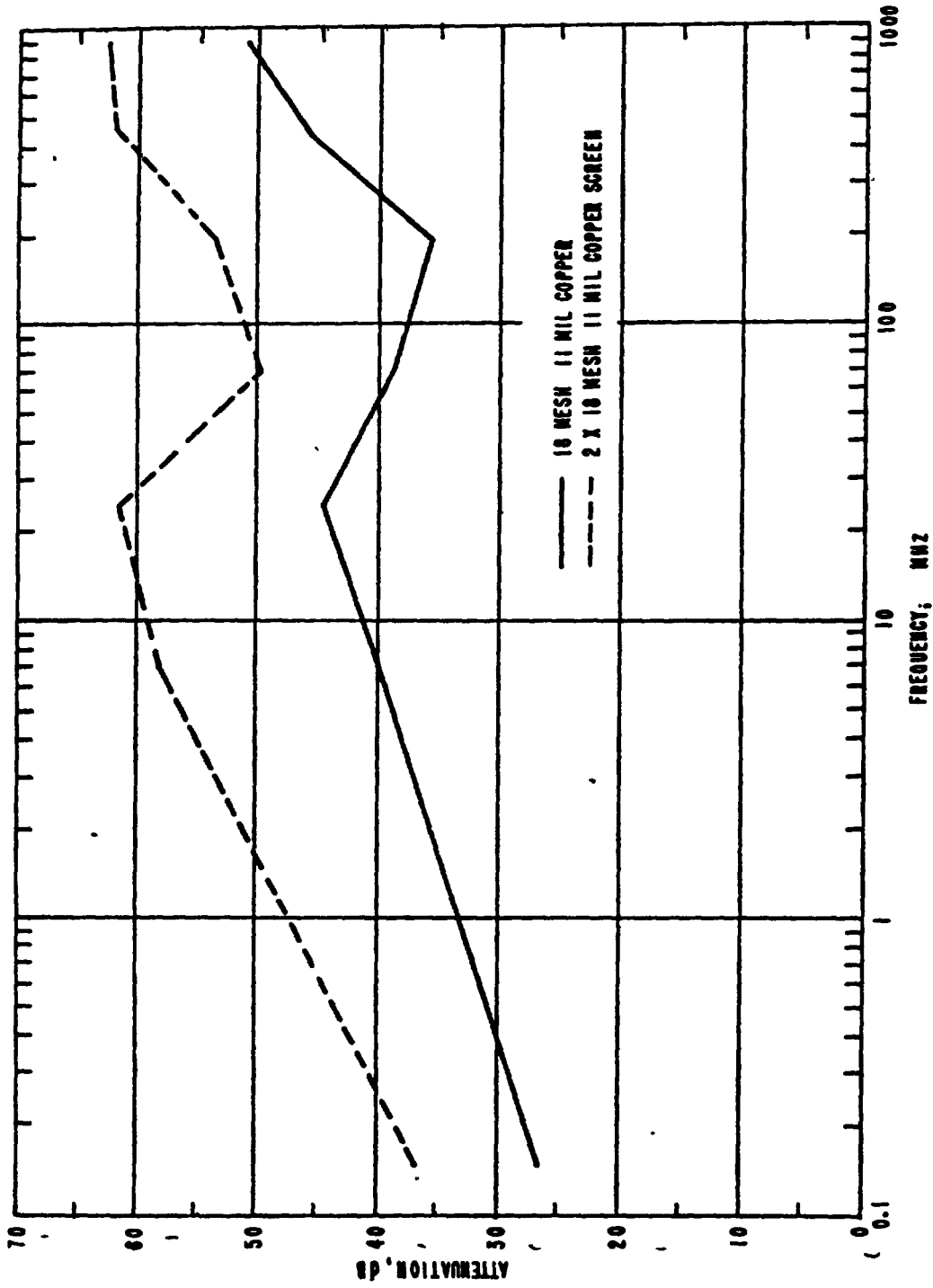

FIGURE B-12. COMPARISON OF THE SHIELDING EFFECTIVENESS OF SINGLE AND DOUBLE 18 MESH COPPER SCREENING

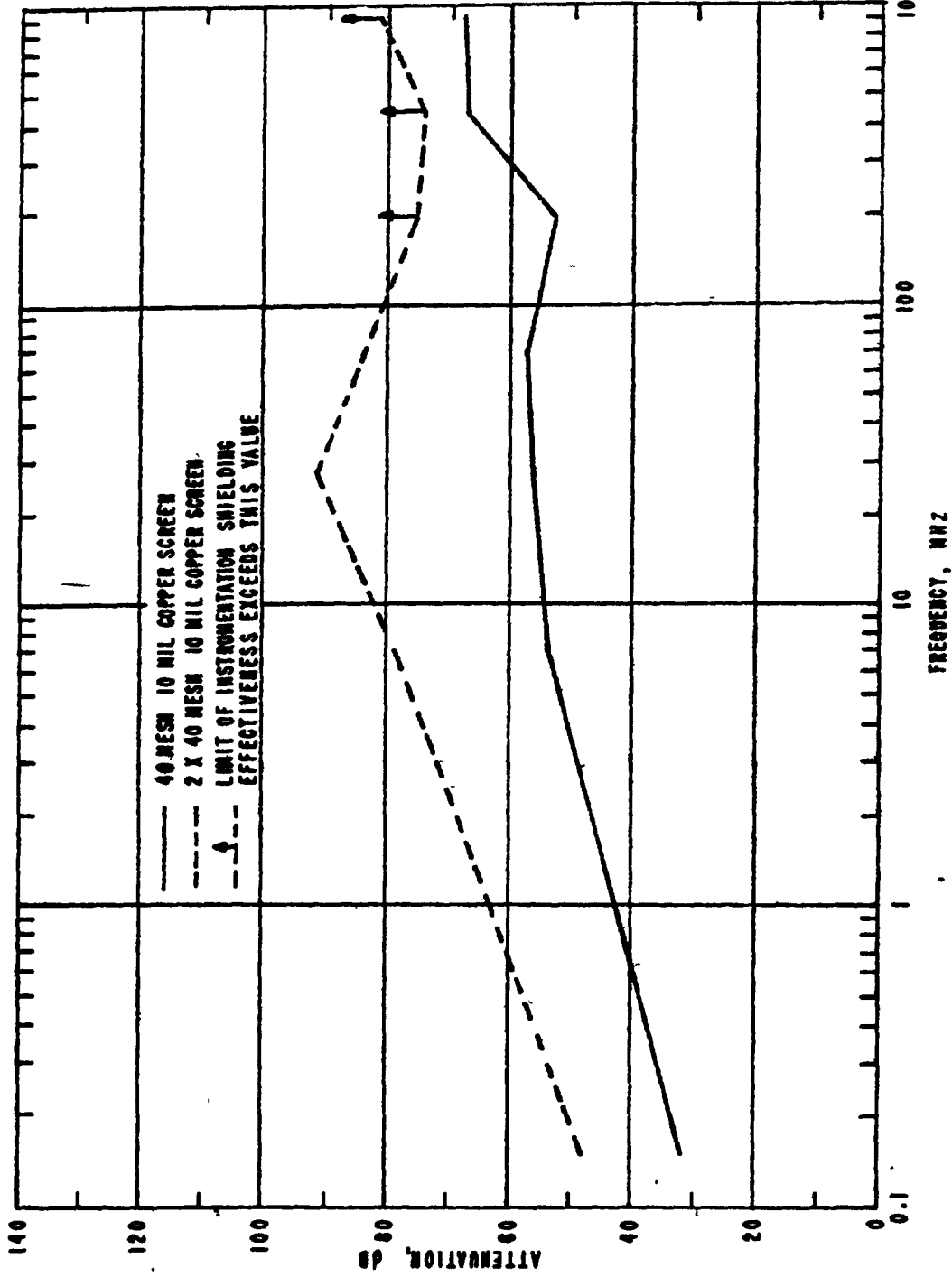

FIGURE B-13 COMPARISON OF THE SHIELDING EFFECTIVENESS OF SINGLE AND DOUBLE 40 MESH COPPER SCREENING

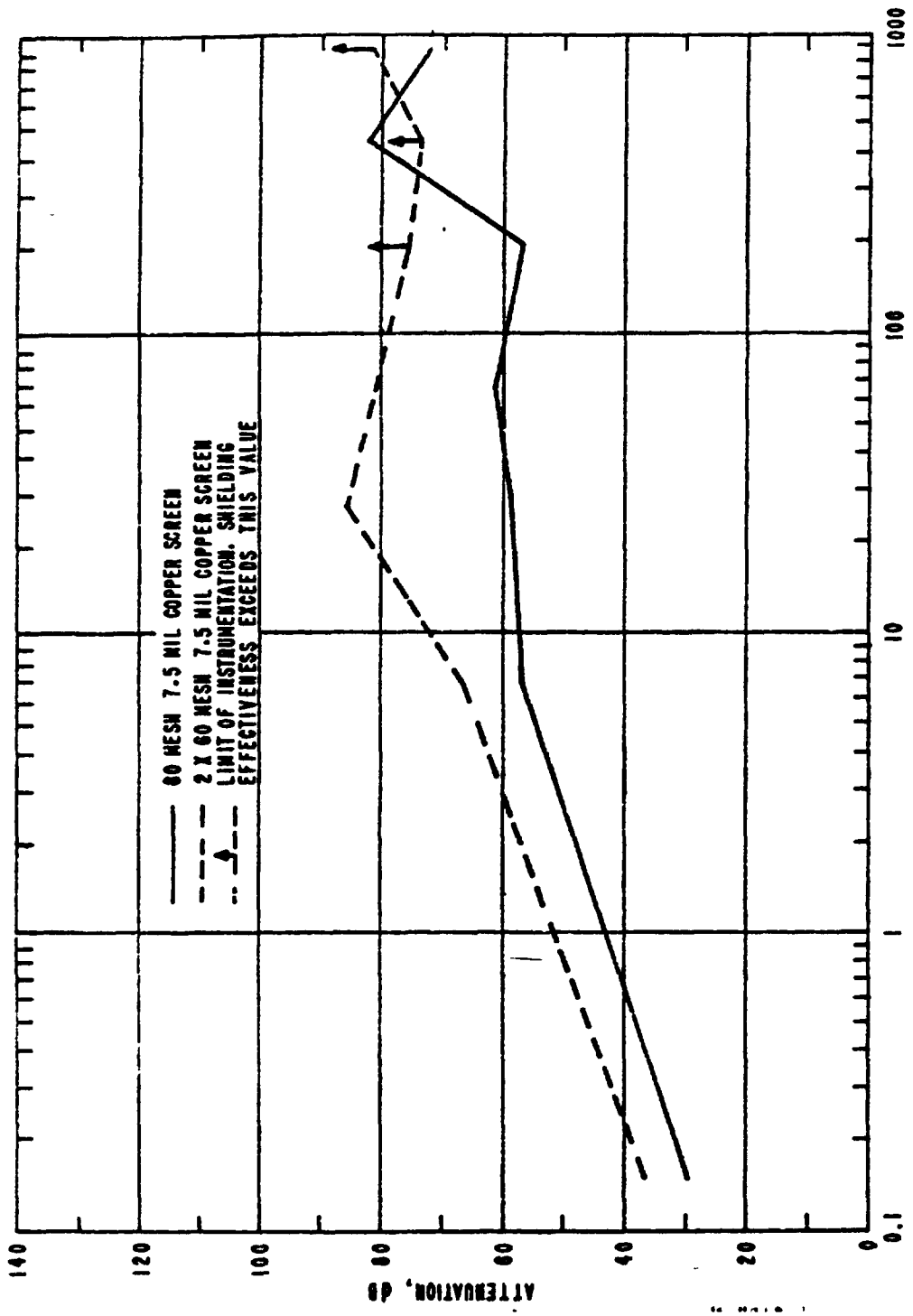

FIGURE B-14. COMPARISON OF THE SHIELDING EFFECTIVENESS OF SINGLE AND DOUBLE 69 MESH COPPER SCREENING

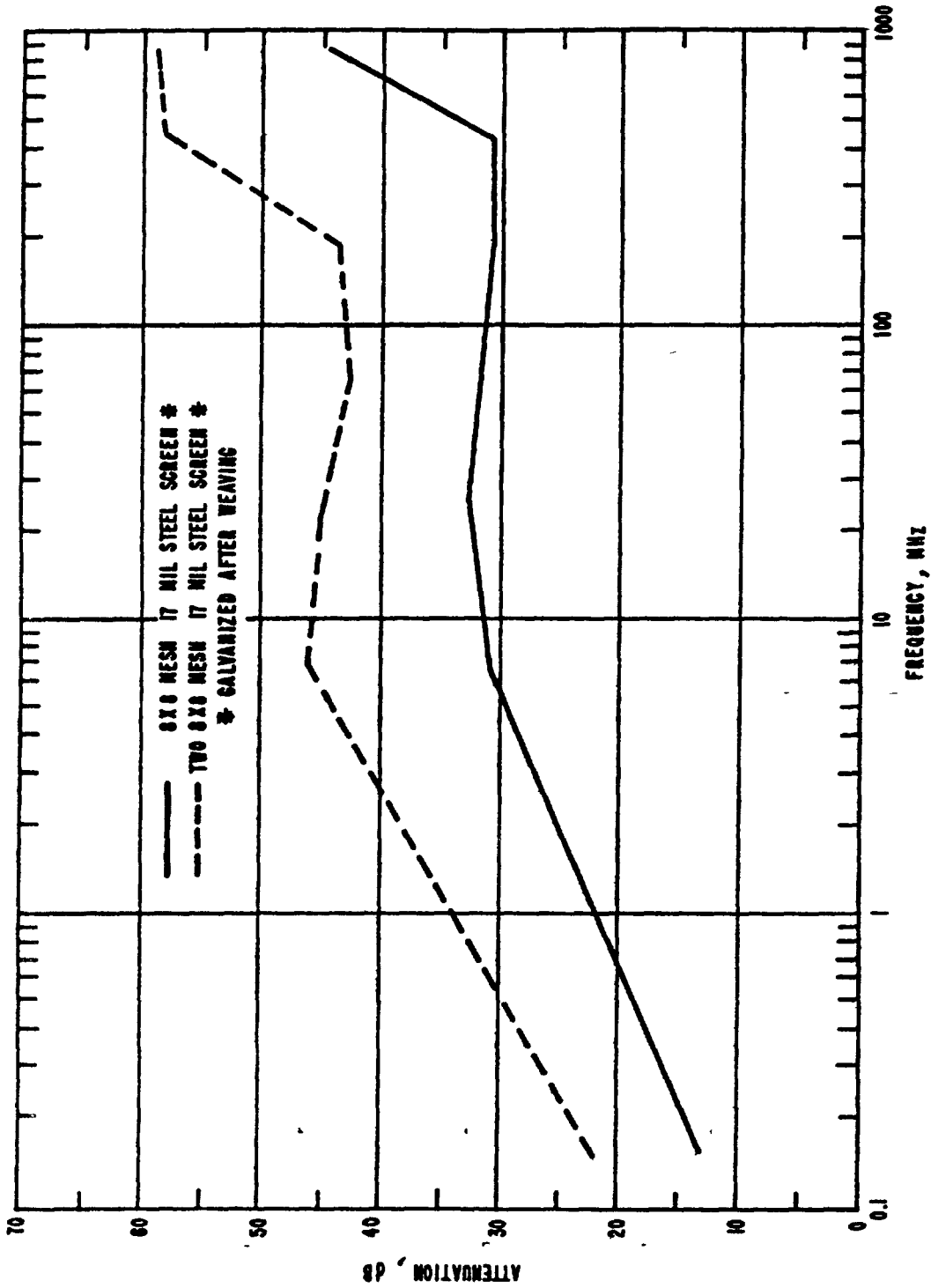

FIGURE B-15. COMPARISON OF THE SHIELDING EFFECTIVENESS OF SINGLE AND DOUBLE 8 MESH GALVANIZED STEEL SCREENING

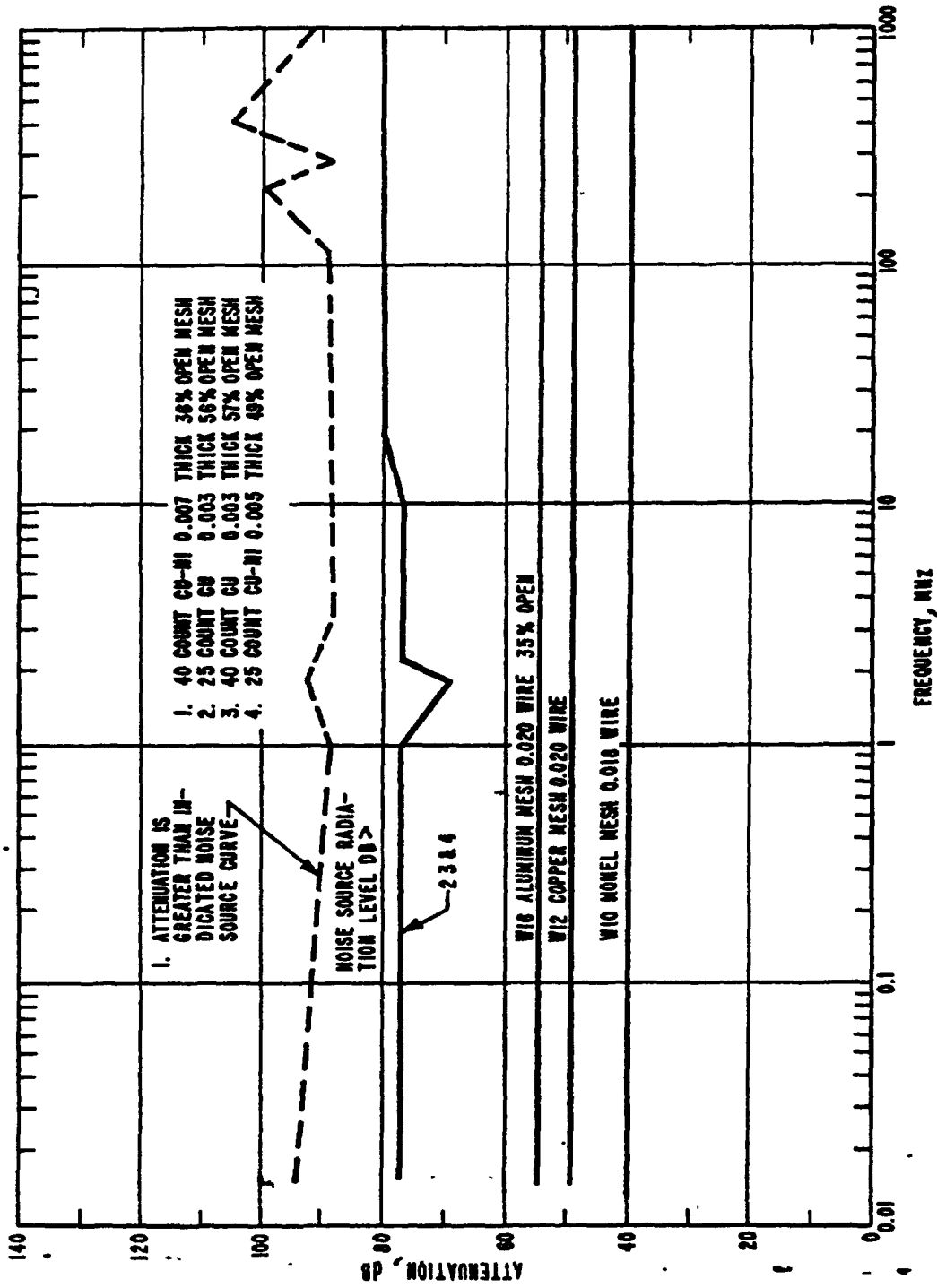

FIGURE B-16. ATTENUATION VERSUS FREQUENCY CURVES FOR VARIOUS SCREENS

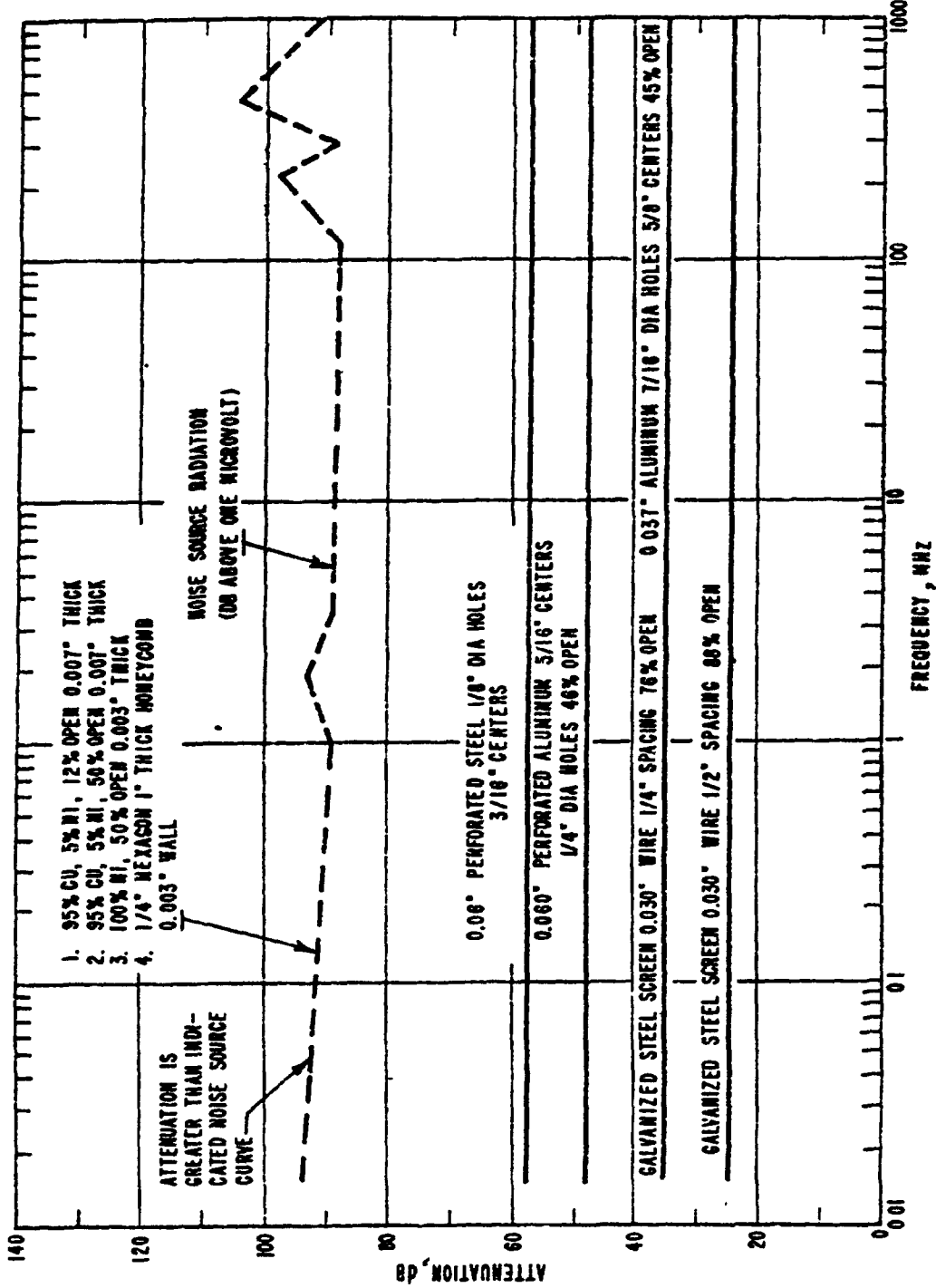

FIGURE B-17 ATTENUATION VERSUS FREQUENCY CURVES FOR VARIOUS SCREENS AND HONEYCOMB

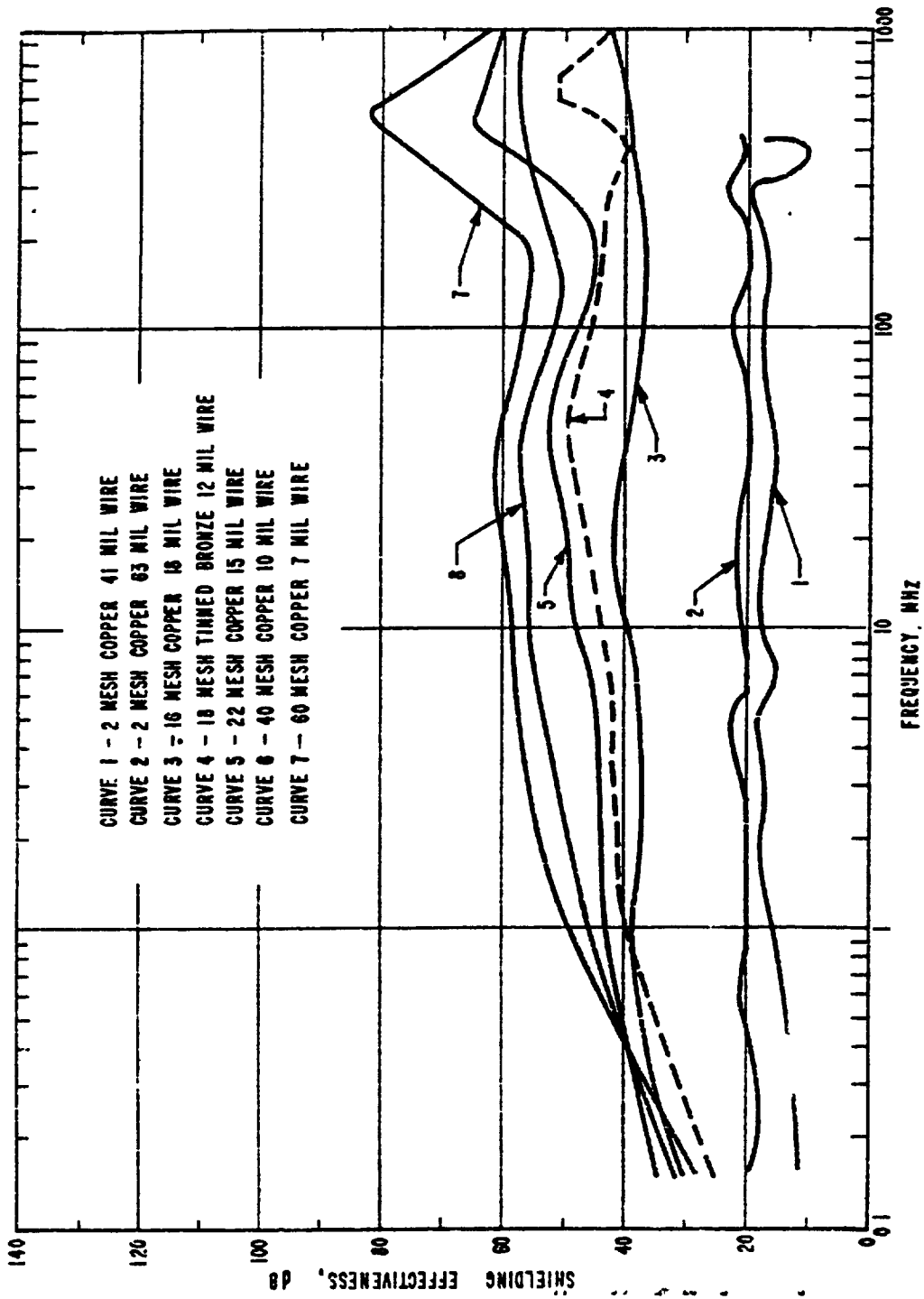

FIGURE B-18. MINIMUM SHIELDING EFFECTIVENESS OF COPPER AND BRONZE SCREENING IN A MAGNETIC FIELD

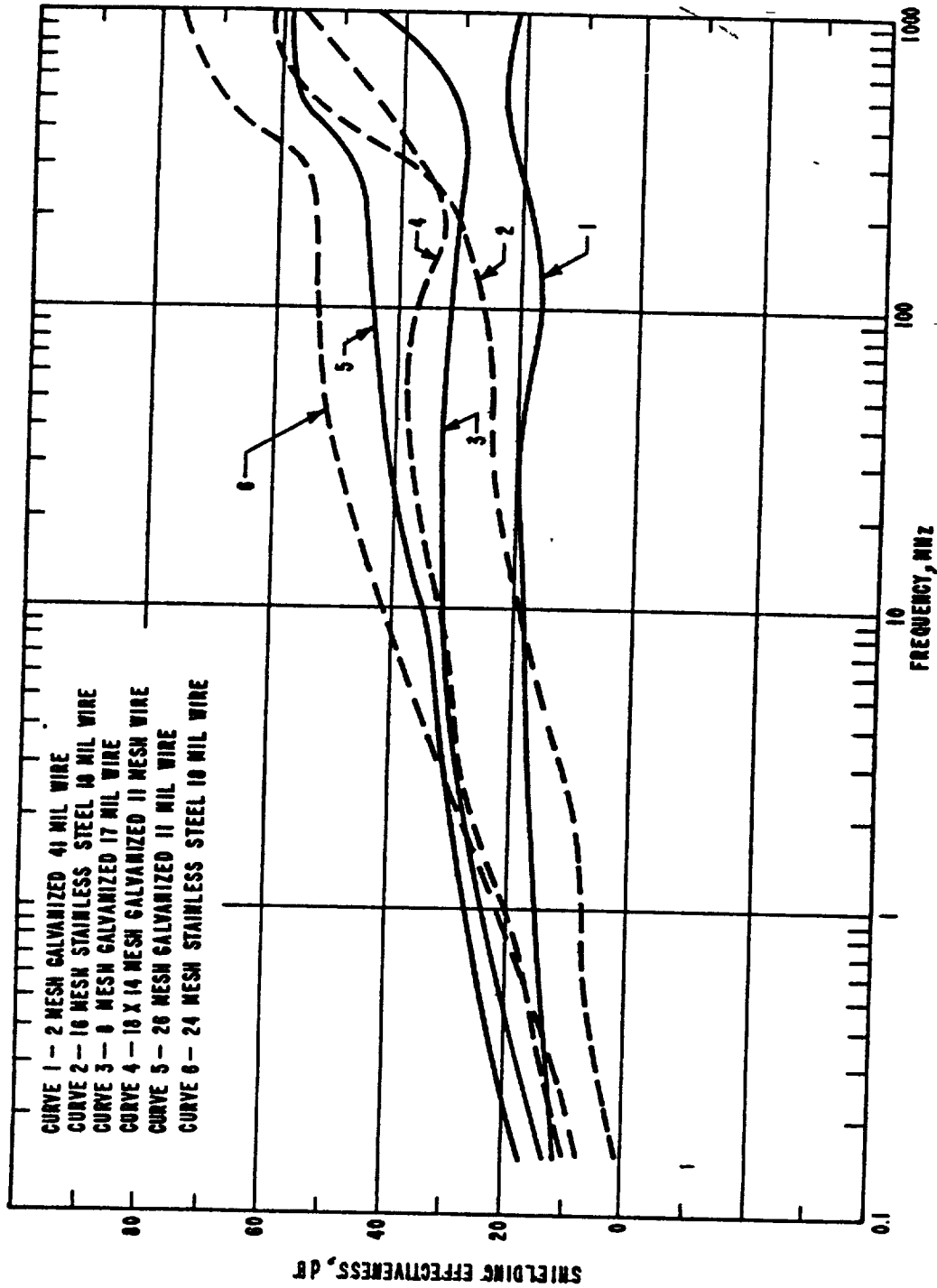

FIGURE B-19. MINIMUM SHIELDING EFFECTIVENESS OF STEEL SCREENING IN A MAGNETIC FIELD

INSTRUCTIONS: In a continuing effort to make our standardization documents better, the DoD provides this form for use in submitting comments and suggestions for improvements. All users of military standardization documents are invited to provide suggestions. This form may be detached, folded along the lines indicated, taped along the loose edge (*DO NOT STAPLE*), and mailed. In block 5, be as specific as possible about particular problem areas such as wording which required interpretation, was too rigid, restrictive, loose, ambiguous, or was incompatible, and give proposed wording changes which would alleviate the problems. Enter in block 6 any remarks not related to a specific paragraph of the document. If block 7 is filled out, an acknowledgement will be mailed to you within 30 days to let you know that your comments were received and are being considered.

NOTE: This form may not be used to request copies of documents, nor to request waivers, deviations, or clarification of specification requirements on current contracts. Comments submitted on this form do not constitute or imply authorization to waive any portion of the referenced document(s) or to amend contractual requirements.

(Fold along this line)

(Fold along this line)

DEPARTMENT OF THE ARMY



NO POSTAGE
NECESSARY
IF MAILED
IN THE
UNITED STATES

OFFICIAL BUSINESS
PENALTY FOR PRIVATE USE \$300

BUSINESS REPLY MAIL
FIRST CLASS PERMIT NO. 12062 WASHINGTON D C.
POSTAGE WILL BE PAID BY THE DEPARTMENT OF THE ARMY

COMMANDING OFFICER
U.S. ARMY ELECTRONICS COMMAND
ATTN: AMSEL-TD-S
FORT MONMOUTH, N.J. 07703

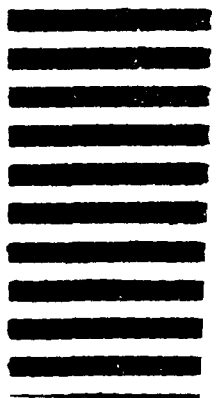

STANDARDIZATION DOCUMENT IMPROVEMENT PROPOSAL

(See Instructions - Reverse Side)

1. DOCUMENT NUMBER		2. DOCUMENT TITLE	
3a. NAME OF SUBMITTING ORGANIZATION		4. TYPE OF ORGANIZATION (Mark one)	
b. ADDRESS (Street, City, State, ZIP Code)		<input type="checkbox"/> VENDOR	
		<input type="checkbox"/> USER	
		<input type="checkbox"/> MANUFACTURER	
		<input type="checkbox"/> OTHER (Specify) _____	
5. PROBLEM AREAS			
a. Paragraph Number and Wording			
b. Recommended Wording			
c. Reason/Rationale for Recommendation			
6. REMARKS			
7a. NAME OF SUBMITTER (Last, First, MI) - Optional		b WORK TELEPHONE NUMBER (Include Code) - Optional	
c. MAILING ADDRESS (Street, City, State, ZIP Code) - Optional		8 DATE OF SUBMISSION (YYMMDD)	

(TO) CATCH THIS FORM. CUT ALONG THIS LINE.